

# Tilbehørskatalog 2017

**YANMAR**



**Gori® propeller**



Kære bådejer!

De sidder nu med første eksemplar af Johs. Thornam's tilbehørskatalog.

Johs. Thornam styrkede maj 2016 sin position i branchen ved opkøbet af G & O Trading og tilbyder derved mange spændende kvalitetsprodukter.

Disse kvalitetsprodukter fremvises delvist i dette katalog.

I år har verden taget en drejning for motorproducenterne. RCD2 er blevet indført januar 2017. Det betyder motorproducenterne ikke længere må sælge motorer, som ikke lever op til de skærpede krav omkring forureningsnormer, bedre kendt som RCD2.

RCD2 er gældende for lystbådmotorer fra 50 hk. i Danmark. Dog må motorer, som er distributøren i hænde, senest 16 jan. 2017 stadig sælges. Grønland og Færøerne er ikke omfattet af RCD2. Erhverv er ikke omfattet af overstående regler for RCD2.

Kataloget viser udelukkende kvalitetsprodukter, som er udvalgt til at fungere optimalt sammen med din Yanmar motor. Du får let adgang til alle produkterne via vores Yanmar forhandlere og samarbejdspartnere.

Yanmar forhandlerne varetager salg, service og support på alle vores reservedele og tilbehørsprodukter.

Dette katalog viser udvalgte produkter, som er tilgængelige hos din Yanmar forhandler, hvor du også kan blive orienteret om det komplette motorprogram. Billederne i dette katalog er udelukkende til information og kan ikke anvendes som installations- eller værkstedslitteratur. I disse tilfælde bør dokumentation hentes i relevant teknisk publikation.

Besøg [www.thornam.dk](http://www.thornam.dk) for at finde nærmeste forhandler, samt se hele vores produktprogram.

Velkommen ombord!

Med venlig hilsen



Salgs- og support teamet.  
[Yanmar@thornam.com](mailto:Yanmar@thornam.com)

Rev. 01.17



# Indholdsfortegnelse

Alle priser er pr. 01.01.2017 vejl. inkl. 25% moms  
og kan ændres uden varsel. Der tages forbehold for evt. trykfejl.

<b>A</b>			
Aftrækkere	21	<b>M</b>	11
Aksel systemer	16	Mastervolt	28-36
Akseltætning	17	Membransæt	5
Akseltætning for vandpumper	6	Motor data udlæsning	12
Antihævertventil	13	Motorer	4
Aqua Base Watermaker	45	Motorolie	11
Automatsikringer	39, 40	Motorregulering	27
<b>B</b>		<b>N</b>	
Batteri isolatorer	32	Nødsignaler	49
Batteri monitor	31, 34	<b>O</b>	
Batterier	44	Olie	11
Batteriladere	30	Oliefiltre	7
Battery switches	37, 38	Oliefyfyr	46
BEP	37 - 43	Olietryksgivere	9
Brændstof forfiltre	8	Ombord kit	12
Brændstoffiltre	9	<b>P</b>	
Brændstofslinger	14	Pains Wessex	49
Bundsi til skroggenemføringer	15	Propelaksler	17
Bøjninger	15	Propeller	19, 20, 21
<b>C</b>		<b>R</b>	
Centa koblinger	16	Reguleringshåndtag	23, 24, 27
<b>D</b>		Riserkit	10
Dc-konvertere	32	<b>S</b>	
<b>E</b>		Sejldrev membransæt	5
Elektronisk motor data udlæsning	12	Sejldrev tætning	5
Ende-zink	21	Selmar Watermaker	47
<b>F</b>		Service kit	12
Filtre	8, 9, 10, 14	Sikkerhedsudstyr	49
Fischer Panda	45	Sikringer	36, 42, 43
Foldepropeller	18, 19, 20	Skorstenssæt	40
Forfiltre	8	Skroggenemføring	15
<b>G</b>		Slangeadapter	13
Gashåndtag	23, 24, 26, 27	Slangenipler	15
Gaskabler	25, 26	Slanger	14
Gear olie	11	Slangestudse	15
Gearhåndtag	23, 24, 27	Spændbånd	14
Gearkabler	25, 26	Stoppers	21, 22
Generator kileremme	7	Styreboks	27
Generators	48	Søvandsfiltre	13
Gennemføringer for udstødning	13	<b>T</b>	
Gori propeller	18 - 22	Temperaturfølere	9
<b>H</b>		Termostater	9
Hagenøgler	22	TFX-bokse	23, 24
<b>I</b>		Transformere	34
Impeller	6	Tærezink	10
Invertere	28	Tætning for vandpumper	6
<b>K</b>		<b>U</b>	
Kabler	25, 26	Udstødnings	13
Kabola oliefyfyr	46	Udstødningsgennemføringer	13
Kileremme	7	Udstødningssslinger	14
Kileremme til generators	7	Udtag	10
Kileremme til vandpumper	7	<b>V</b>	
Klemflanger	16	Vandlåse	13
Kombi-invertere	28, 29	Vandpumpe kileremme	7
Kugleventiler	15	Vandrensere	45, 47
Kølervæske	11	Varmtvandsudtag	10
Kølevandssslinger	14	Ventilslibesæt	5
<b>L</b>		<b>Y</b>	
Ladegenerator	33	Yanmar	4 - 12
Ladere	28, 29, 30	<b>Z</b>	
Landstrømtavler	33	Zink	10, 21, 22
Luffiltre	10		
Lyddæmpere	13		

# Nye kræfter til din båd?

Yanmar har motorer fra 9 til 900 HK

YM-Serien



14-29 HK • 2-3 cyl • vægt 113-133 kg

JH CR-Serien

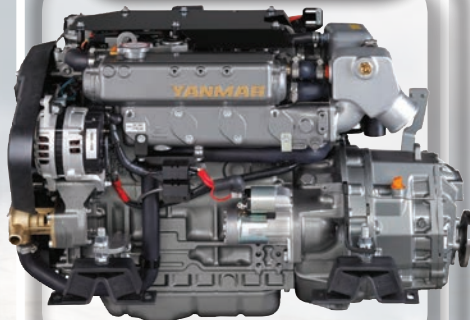

39-125 HK • 3-4 cyl • vægt 185-260 kg

8LV-Serien

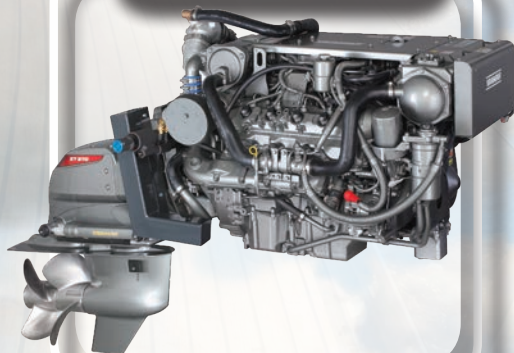

320-370 HK • 8 cyl • vægt 435 kg

LY-Serien



380-480 HK • 6 cyl • vægt 530-718 kg

Med Yanmar motorer får du samtidig et verdensomspændende net af forhandlere og serviceværksteder. Du får en super motor med service overalt i Danmark og resten af verden.

**YANMAR**

**johs  
thornam**

KVALITET TIL SØS • WWW.THORNAM.DK • 4434 2040



## Ventilslibesæt

Ventilslibesæt med toppakning og andre pakninger, der behøves for montering af topstykket.

Varenr.	Beskrivelse	Vejl. uds. incl. moms
900-001	YSE/YSB/YSM 8	kr 675,00
900-002	YSE/YSB/YSM12	kr 687,50
900-003	2QM 15	kr 2.037,50
900-004	2QM 20	kr 1.575,00
900-005	3QM 30	kr 2.425,00
900-006	1GM	kr 1.300,00
900-007	1GM 10	kr 1.250,00
900-008	2GM	kr 2.225,00
900-009	2GM F	kr 2.400,00
900-010	2GM 20	kr 1.875,00
900-011	2GM 20 F	kr 2.037,50
900-012	3GM	kr 3.225,00
900-013	3GM F	kr 3.300,00
900-014	3GM 30	kr 2.737,50
900-015	3GM 30 F	kr 2.725,00
900-016	3HM	kr 2.887,50
900-018	3HM 35 F	kr 3.237,50
900-019	4JH E	kr 3.612,50
900-020	4JH TE	kr 4.350,00
900-021	4JH HTE	kr 3.887,50
900-022	4JH DTE	kr 3.500,00
900-023	4LH TE	kr 4.600,00
900-024	4LH HTE	kr 4.600,00
900-028	4JH2 TE	kr 3.725,00
900-030	4JH2 DTE	kr 3.700,00
900-031	4JH2 UTE	kr 3.700,00
900-032	4LH DTE	kr 4.975,00
900-033	3JH3 E	kr 2.475,00
900-034	4JH3 E	kr 2.462,50
900-035	4LH-STE	kr 5.325,00
900-036	4JH3-HTE	kr 4.350,00
900-037	4JH3-DTE	kr 5.187,50
900-040	2YM15	kr 1.900,00
900-041	3YM20	kr 2.700,00
900-042	3YM30	kr 2.700,00
900-043	3JH4 / 3JH5E	kr 2.425,00
900-044	4JH4E / 4JH5E	kr 2.750,00
900-045	4JH45CR / 4JH57CR	kr 3.125,00



## Sejldrev tætning

Reparationsæt med akseltætninger for propelakslen på SD-Sejldrev.

Varenr.	Beskrivelse	Vejl. uds. incl. moms
196313-02590-Q	AKSELTÆTNING, UD GANGSAKSEL SD 20 / 25 / 30 / 31	kr 250,00
196440-02870-Q	AKSELTÆTNING, UD GANGSAKSEL SD 40 / 40T / 50 / 50 T	kr 1.312,50
196460-02620-Q	AKSELTÆTNING, UD GANGSAKSEL SD 60	kr 575,00



## Sejldrev membransæt

Membransæt for Yanmar sejldrev incl. diverse pakninger. Olie købes separat.

Varenr.	Beskrivelse	Vejl. uds. incl. moms
950-001	MEMBRANSÆT SD20-SD25-SD30-SD31	kr 3.950,00
950-002	MEMBRANSÆT SD40-SD50	kr 3.950,00
950-003	MEMBRANSÆT SD60	kr 5.075,00
196420-02551	UDVENDIG MEMBRAN FOR ALLE YANMAR DREV	kr 487,50
700-900-Q	VOLVO KONVERTERINGS RING SÆT FOR SD SEJLDREV	kr 7.787,50



## Akseltætning for vandpumper

Servicesæt for søvandpumper.

Varenr.	Beskrivelse	Vejl. uds. incl. moms
X02233010-Q	YM	kr 231,25
X0529105-Q	3JH3E / 4JH3E / 4JH3TE / 4JH3HTE / 4JH3DTE / 6LPDTE / 6LPSTE	kr 500,00
X0529139-Q	2GM20EU / 2GM20FEU / 3GM30EU / 3GM30FEU	kr 206,25
104211-42100-Q	YSE / YSB / YSM / 2GM / 2GM20 / 3GM / 3GM30	kr 156,25
105582-42110-Q	AKSELTÆTNING FOR VANDPUMPE SB8,SB12	kr 275,00
123472-42060-Q	KERAMISK 4LHTE / 4LHDTE / 4LHSTE(P) / 4LHHTE	kr 1.462,50
124223-42080-Q	3GMF / 3HM / 3HMF / 3HM35 / 3HM35F / 2GM20F / 3GM30F	kr 175,00
128170-42110-Q	1GM / 1GM10	kr 237,50
129670-42560-Q	MEKANISK 3JH2E / 3JH2TE / 3JH4E / 4JH4E / 4JH5E / 4JH45CR / 4JH57CR / 4JH80CR / 4JH110CR	kr 2.050,00
24421-203508-Q	4JHE / 4JHTE / 4JHHTE / 4JHDTE / 4JH2E / 4JH2TE / 4JH2HTE / 4JH2DTE / 4JH2UTE	kr 115,00
24421-203508-Q14	LHTE / 4LHHTE / 4LHDTE / 4LHSTE(P) / 4LHAHTP / 4LHADTP / 4LHASTP	kr 92,50
24422-153007-Q	AKSELTÆTNING FOR VANDPUMPE 2QM20,3QM30	kr 312,50



## Impeller

Impeller sæt incl. pakning. Impeller er i høj kvalitet for længere levetid. Hav altid en ekstra reserve impeller ombord!

Varenr.	Beskrivelse	Vejl. uds. incl. moms
X08810B-Q	INCL. PAKNING 2GM20EU / 2GM20FEU / 3GM30EU / 3GM30FEU	kr 312,50
104211-42070-Q	INCL. PAKNING SB / YSE / YSB / YSM / 2QM15 / 2GM / 3GM / 2GM20 / 3GM30	kr 362,50
119773-42600-Q	INCL. PAKNING 6LP-DTE / 6LP-STE / 6PLA-DTE(P) / 6LPA-DTZE(P)	kr 550,00
127610-42200-Q	BY / BY2	kr 475,00
128176-42071-Q	INCL. PAKNING 1GM / 1GM10	kr 237,50
128296-42070-Q	INCL. PAKNING 2QM20 / 3QM30 / 3GMF / 3HM / 3HMF / 3HM35 / 3HM35F / 2GM20F / 3GM30F	kr 575,00
128990-42200-Q	INCL. PAKNING YM	kr 231,25
129470-42531-Q	INCL. PAKNING 4JHE / 4JHTE / 4JHDTE / 4JHHTE / 4JH2E / 4JHTE / 4JHDTE / 4JHUTE / 3JH2E / 3JH2TE	kr 1.062,50
129670-42530-Q	INCL. PAKNING 3JH4E / 3JH5E / 4JH4E / 4JH4AE / 3JH3E / 4JH3E / 4JH3TE / 4JH3HTE / 4JH3DTE / 4JH45CR / 4JH57CR / 4JH80CR / 4JH110CR	kr 362,50





## Kileremme til generatorer

Varenr.	Beskrivelse	Vejl. uds. incl. moms
104211-42780-Q	YSE8 / YSB8	kr 95,00
104271-77350-Q	YSM8 / 12	kr 137,50
105282-77790-Q	SB8	kr 137,50
105582-77790-Q	2QM15 / 1GM10	kr 181,25
119773-77251-Q	6LP-DTE / 6LP-STE	kr 287,50
119831-42290-Q	3YM20, 3YM30	kr 218,75
128990-77580	3YM20, 3YM30 (MULTIREM)	kr 131,25
120640-00010	4BY150 / 180 // 4BY2-150 / 4BY2-180 / 6BY220 / 6BY2-220 / 6BY260 / 6BY2-260	kr 350,00
120640-00020	4BY150Z / 180Z / 6BY220Z / 260Z / 4BY2-150Z / 4BY2-180Z / 6BY2-220Z / 6BY2-260Z	kr 525,00
121850-42280-Q	LH-TE / LH-HTE / LH-DTE	kr 450,00
123672-77370-Q	3HM 35	kr 137,50
128170-77350-Q	1GM / 1GM10	kr 181,25
128670-77350-Q	3HM / 2GM20 / 3GM30	kr 212,50
128695-44780-Q	3HMF	kr 243,75
129612-42290-Q	2YM15	kr 275,00
128790-77580	2YM15 (MULTIREM)	kr 125,00
171087-42280-Q	3JH2 / 3JH3	kr 437,50
25112-003601-Q	2GMF / 3GMF	kr 206,25
25112-004000-Q	3HM35F	kr 500,00
25117-003151-Q	2QM20 / 3QM30	kr 197,50
25132-003000-Q	2GM / 3GM	kr 181,25
25132-003700-Q	2GM20F / 3GM30F	kr 218,75
25132-003800-Q	3JH4 / 3JH4E / 3JH5E / 4JH4E / 4JH4AE / 4JH4-HTE / 4JH5E	kr 212,50
25152-004300	3JH4E / 3JH5E / 4JH4E / 4JH4AE / 4JH5E	kr 362,50
25132-004600-Q	4JH2 / 4JH3 / 4JH4-TE / 4JH4-HTE / 4JHE / 4JH-TE / 4JH-HTE / 4JH-DTE / 4JH2-E / 4JH2-TE / 4JH2-HTE / 4JH2-DTE / 4JH2-UTE / 4JH-E / 4JH3-TE / 4JH3-HTE / 4JH3-DTE	kr 250,00
129671-77680	4JH4-TE / 4JH4-HTE (MULTIREM)	kr 150,00
129675-42280	4JH45CR / 4JH57CR / 4JH80CR / 4JH110CR	kr 737,50



## Kileremme til vandpumper

Varenr.	Beskrivelse	Vejl. uds. incl. moms
104214-42780-Q	YSE8 / YSB8	kr 181,25
104511-78780-Q	YSM8 / YSM12 / 2GM / 3GM / 3HM / YM	kr 150,00
104514-42780-Q	YSE12 / YSB12	kr 325,00
104514-77350-Q	2QM15	kr 187,50
120650-42360	BY / BY2	kr 275,00

## Oliefiltre

Yanmar oliefiltre er udviklet til at give motoren maksimal levetid og driftssikkerhed. Følg altid udskiftningsintervallerne i instruktionsbogen, dog mindst en gang årligt.

Varenr.	Beskrivelse	Vejl. uds. incl. moms
119005-35170	4LH-TE / 4LH-HTE	kr 105,00
119305-35170	2QM15 / GM / YM / 3JH2 / 3JH3 / 3JH4	kr 60,00
119770-90620	6LP-DTE / 6LP-STE	kr 475,00
124085-35170	2QM20 / 3QM30 / 3HM	kr 111,25
127695-35160	4LH-DTE / 4LH-STE(P) / 4LHA-HHTTP / 4LHA-DTP / 4LHA-STP	kr 218,75
129150-35170	4JH / 4JH2 / 4JH3 / 4JH4 / 4JH---CR	kr 73,75
165000-69520	4BY150 / 150Z / 4BY180 / 180Z / 4BY2-150 / 150Z / 4BY2-180 / 180Z	kr 312,50
165000-69590	6BY220 / 220Z / 6BY260 / 260Z / 6BY2-220 / 220Z / 6BY2-260 / 260Z	kr 325,00



## Brændstof forfiltre

Brændstof forfilter / vandudskilningsfilter til montering mellem brændstoftank og motoren for at forhindre, at der kommer vand og andre urenheder i motorens brændstofs-system, som kan forårsage skade på motoren. Nippeler skal købes separat.

Varenr.	Beskrivelse	Vejl. uds. incl. moms
R120AT	RACOR FILTER FUEL KOMPLET 30 MIC 57.L/T PLAST M: R12P 30MIC, 1/4-18NPT FOR YANMAR 1GM10, 2YM15 & 2GM20	kr 1.260,00
R230R30	RACOR FILTER FUEL KOMPLET 30 MIC. 114L/T PLAST M: R20P 30MIC, 1/4-18NPT FOR YANMAR YM-SERIE & JH-SERIE	kr 2.116,25
R500FG30	RACOR FILTER FUEL KOMPLET 30 MIC 227L/T PLAST M: R20P 30MIC, 3/4-16UNF FOR YANMAR BY-SERIE, LH-SERIE & LP-SERIE	kr 3.100,00
R1000FHP30	RACOR FILTER FUEL KOMP. 30MIC 681.L/T PLAST BOWL	kr 4.892,00
R75/1000FGXP30	RACOR FILTER FUEL KOMP. DOBBELT 30MIC 2 x 681.L/T PLAST BOWL	kr 16.600,00
R12P	RACOR FUEL FILTERELEMEN 30MIC F: R120AT	kr 285,00
R20P	RACOR FUEL FILTERELEMEN 30MIC F: R230RM	kr 407,50
R2010PM-OR	RACOR FUEL FILTERELEMEN 30MIC F:500FGMP	kr 183,75
R2020PM-OR	RACOR FUEL FILTERELEMEN 30MIC F: R1000FHP30 OG R75/1000FGXP30	kr 242,00
R911-08-H6	RACOR SLANGE STUDS 9 mm (R500FG30) 3/4-16UNF60 stk LIGE MESS.	kr 85,00
R-FITTINGS-9mm-Q	RACOR FITTING F/R120 & R230 9 mm 90° SÆT AF 2 (2 DELT)	kr 525,00
R-FITTINGS-9mm-Q1	RACOR FITTING F/R120 & R230 9 mm LIGE SÆT AF 2 (2 DELT)	kr 350,00
R500FITTINGS-9mm-Q	RACOR FITTING F/R500 9 mm SL. 90° SÆT AF 2 (2 DELT)	kr 387,50
R500FITTINGS-9mm-Q1	RACOR FITTING F/R500 9 mm LIGE SÆT AF 2 (2 DELT)	kr 375,00
R500FITTINGS-16mm-Q	RACOR FITTING F/R500 16 mm SL. 90° SÆT AF 2 (2 DELT)	kr 962,50
R500FITTINGS-16mm-Q1	RACOR FITTING F/R500 16 mm LIGE SÆT AF 2 (2 DELT)	kr 662,50





## Brændstoffiltre

Yanmar brændstoffilter forhindrer at forurenede brændstof cirkulerer i motorens brændstofsistem. Følg altid udskriftsintervallerne i instruktionsbogen, dog mindst en gang årligt. OBS! Sørg altid for at have et reservefilter ombord.

Varenr.	Beskrivelse	Vejl. uds. incl. moms	
104500-55710-Q	INCL. PAKNING SB / YSE / YSB / YSM / QM / GM / HM / YM	kr	168,75
119773-55510	6LP-DTE / 6LP-STE	kr	612,50
120650-55020	VANDUDSKILNINGSFILTER ELEMENT BY-SERIE	kr	562,50
120650-55040	INLET BY	kr	412,50
120651-55020	ELEMENT 4BY2 / 6BY2	kr	762,50
121857-55710	4LH-TE / 4LH-HTE / 4LHA-HTTP	kr	337,50
129470-55810	3JH3E / 3JH4 / 4JH / 4JH2E / 4JH2TE / 4JH2HTE / 4JH2DTE / 4JH4E	kr	80,00
129574-55711	4JH2UTE / 4JH3TE / 4JH3HTE / 4JH3DTE	kr	462,50
41650-502320	4LH-DTE / 4LH-STE(P) / 4LHA-DTP / 4LHA-STP	kr	150,00
119802-55810	3JH5E / 4JH4AE / 4JH5E	kr	96,25
120324-55760	VANDUDSKILLER FILTER 3JH5E / 4JH5E	kr	237,50
129A00-55800	4JH45CR / 4JH57CR / 4JH80CR / 4JH110CR	kr	600,00



## Termostater incl. pakninger

Varenr.	Beskrivelse	Vejl. uds. incl. moms	
105582-49200-Q	INCL. PAKNING SB / YSE / YSB / YSM / 1GM / 2GM / 3GM / 1GM10 / 2GM20 / 2GM20EU / 3GM30 / 3GM30EU	kr	425,00
105582-49200-Q1	INCL. PAKNING 3QM30	kr	412,50
105582-49200-Q2	INCL. PAKNING 3HM / 3HM35	kr	425,00
119773-49550-Q	INCL. PAKNING 6LP-DTE / 6LP-STE	kr	1.100,00
121750-49800-Q	INCL. PAKNING 2GMF / 3GMF / 3HMF / 3HM35F / 2GM20F / 2GM20F-EU / 3GM30F / 3GM30F-EU	kr	425,00
124770-49200-Q	INCL. PAKNING 2QM15 / 2QM20	kr	475,00
121850-49810-Q	INCL. PAKNING 4LH / 4LHA	kr	387,50
128990-49800-Q	INCL. PAKNING YM	kr	400,00
129470-49801-Q	INCL. PAKNING 3JH4 / 3JH5E / 4JH4E / 4JH2-E / 4JH2-TE / 4JH2-HTE / 4JH2-DTE / 4JH2-UTE / 3JH2 / 3JH3 4JH5E	kr	1.075,00
129470-49801-Q1	INCL. PAKNING 4JH-E / 4JH-TE / 4JH-HTE / 4JH45CR / 4JH57CR / 4JH80CR / 4JH110CR	kr	1.062,50
165001-98630	THERMOSTAT ASSY BY / BY2	kr	562,50



## Olietryksgivere

Varenr.	Beskrivelse	Vejl. uds. incl. moms	
114250-39450-Q	OLIETRYKSGIVER 0.5 YM	kr	150,00
120650-39270	OLIETRYKSSENSOR BY / BY2	kr	2.487,50
121252-39450-Q	OLIETRYKSGIVER 3JH5E / 4JH45CR / 4JH57CR / 4JH80CR / 4JH110CR	kr	162,50
124060-39452-Q	OLIETRYKSGIVER 0,2 KG GM / HM / 3JH4 / 4JH5E / 4JH4E / 4JH4AE / 4JH / 4JH2 / 3JH2 / 3JH3 / 4JH3 / 4LH / 4LHA / 6LP	kr	168,75
165001-98630	OLIETRYKSSWITCH BY / BY2	kr	562,50



## Temperaturfølere

Varenr.	Beskrivelse	Vejl. uds. incl. moms	
120130-91370-Q	3JH4 / 3JH5E / 4JH4E / 4JH5E / 4JH2 / 3JH2 / 3JH3E / 4JH3	kr	612,50
127610-91350-Q	2GMF / 2GM20F / 2GM20F-EU / 3GMF / 3GM30F / 3GM30F-EU / 3HMF / 3HM35F / 4JH / 4LH/4LHA / 6LP	kr	512,50
128275-91340-Q	1GM / 1GM10 / 2GM / 2GM20 / 2GM20-EU / 3GM30 / 3GM30-EU / 3GM / 3HM / 3HM35	kr	362,50
165000-70660	BY / BY2	kr	387,50
46150-503100-Q	TEMPERATURFØLER MED PAKNING YM	kr	687,50
46150-004531	TEMPERATURGIVER SB / YSE / YSB / YSM / QM	kr	275,00
129927-44900	TEMPERATURFØLER 4JH45CR / 4JH57CR / 4JH80CR / 4JH110CR	kr	612,50

## Tærezink

Yanmar zinkanoder er vigtige for at beskytte motoren mod galvanisk tæring i kølesystemt. Brug altid original zink.

Varenr.	Beskrivelse	Vejl. uds. incl. moms
104211-41300-Q	INCL. PAKNING SB / YSE / YSB	kr 150,00
119773-92600	ZINK SÆT 4LHA / 6LP(A)-DTE(P) / STE(P)	kr 825,00
177301-54900	4LH STE(P)	kr 102,50
196450-02491	TÆRE RING KIT, ANODE AL SD20,40,50	kr 425,00
196450-02500	SEPARAT ANODE, AL, LØSE HALVDELE T/ 196450-02491	kr 175,00
27210-200200-Q	Inkl. PAKNING 1GM / 1GM10	kr 123,75
27210-200300-Q	INCL. PAKNING YSM	kr 117,50
27210-200300-Q1	INCL. PAKNING 2QM15	kr 212,50
27210-200300-Q2	INCL. PAKNING 2QM20 / 3QM30	kr 300,00
27210-200300-Q3	INCL. PAKNING 2GM / 2GM20	kr 200,00
27210-200300-Q4	INCL. PAKNING 3GM / 3GM30 / 3HM / 3HM35	kr 287,50
27210-200550-Q	INCL. PAKNING SD20 / SD30 / SD31	kr 131,25
120650-13420-Q	TÆREZINK SÆT 4BY / 4BY2 / 6BY / 6BY2	kr 687,50
196420-02652-QV	TÆREZINK, RING YANMAR SD DREV MED VOLVO PROPEL	kr 840,00
196350-22200	ANODEKIT ALLE F/ ZT350/ 370 DREV	kr 1.850,00



## Luftfiltre

Originale Yanmar luftfiltre sørger for at beskytte motorens luftindtag og giver motoren sikker drift.

Varenr.	Beskrivelse	Vejl. uds. incl. moms
120650-12510	LUFTFILTER 4BY / 4BY2	kr 1.175,00
120660-12510	LUFTFILTER 6BY 6BY2	kr 987,50
124770-12540	LUFTFILTER QM / 3HM	kr 375,00
128170-12540	LUFTFILTERELEMENT 1GM	kr 181,25
128171-12540	LUFTFILTERELEMENT 1GM10	kr 181,25
128270-12540	LUFTFILTERELEMENT 2GM / 3GM / 2GM20 / 3GM30 / YM	kr 337,50
129271-12311	LUFTFILTER 3JH4E / 3JH5E / 4JH4E / 4JH4AE / 4JH5E / 4JH45CR / 4JH57CR / 4JH80CR / 4JH110CR	kr 300,00
129470-12301	4JH4-TE / 4JH4-HTE	kr 1.450,00
129470-12330	LUFTFILTER 3JH2-TE / 4JH / 4JH2 / 4JH3 / 4JH3-TE / 4JH3HTE / 4JH3-DTE	kr 312,50
XN199611	LUFTFILTERELEMENT 6LP	kr 325,00



128171-12540

## Riserkit

Riserkit installeres i både, hvor udstødningshøjden er lav, f.eks. i langkølede både, eller hvor det er svært at få frit fald fra udstødning på motoren og til lydpotten pga. manglende plads.

Varenr.	Beskrivelse	Vejl. uds. incl. moms
124070-13520-Q	YM SERIE	kr 4.987,50
129472-13501-Q	JH SERIE / 4JH4E-TE / 4JH4E-HTE	kr 12.000,00
129470-13541-Q	JH SERIE / 3JH3E / 3JH4E / 3JH5 / 4JH4E	kr 7.675,00



## Udtag for varmt vand

Udtag for varmt vand til f.eks. varmtvandsbeholder, kalorifer, etc.

Varenr.	Beskrivelse	Vejl. uds. incl. moms
128990-49320-Q	HOTWATER KIT FOR YM-SERIE	kr 625,00
128990-49320-Q1	HOTWATER KIT FOR GM/JH-SERIE	kr 1.225,00





## Olie

Yanmar original motorolie sikrer motorens drift og øger dens levetid.

Varenr.	Beskrivelse	Vejl. uds. incl. moms
0W40-1	MOTOR OLIE SAE 0W40 SYNTETISK, 1 liter (SPECIAL OLIE FOR BY-SERIEN)	kr 205,00
0W40-5	MOTOR OLIE SAE 0W40 SYNTETISK, 5 liter (SPECIAL OLIE FOR BY-SERIEN)	kr 950,00
15W40-1L	MOTOR OLIE SAE15W40, 1 liter FOR YM, JH, LH, LP & LY SERIEN	kr 85,00
15W40-5L	MOTOR OLIE SAE15W40, 5 liter FOR YM, JH, LH, LP & LY SERIEN	kr 325,00



## Gear olie

Varenr.	Beskrivelse	Vejl. uds. incl. moms
SAE30-1L	YANMAR PREMIUM TRANSMISSION OIL SAE30	kr 75,00
80W90-1L	YANMAR PREMIUM SAILDRIVE OIL (SD20 / 25)	kr 92,00
ATF-1L	YANMAR ATF FLUID	kr 92,00
GREASE-COMPLEX	YANMAR MULTI-PURPOSE GREASE 400 g	kr 89,00
GREASE-CALCIUM	YANMAR LITHIUM CALCIUM GREASE 400 g	kr 78,00
GREASE-TEFLON	YANMAR LITHIUM PTFE GREASE 400 g	kr 145,00



## Kølevæske

Yanmar original coolant er færdigblandet til direkte brug. Dette er den eneste form for coolant, der må bruges til BY-serien.

Varenr.	Beskrivelse	Vejl. uds. incl. moms
COOLANT-1L	YANMAR COOLANT XLC 1 L	kr 70,00
COOLANT-5L	YANMAR COOLANT XLC 5 L	kr 265,00



## Maling

Yanmar reparations maling.

Varenr.	Beskrivelse	Vejl. uds. incl. moms
PAINT-001	YANMAR ORIGINAL MALING SPRAY 457 ml	kr 350,00
PAINT-002	YANMAR ORIGINAL MALING FLASKE 17,7 ml	kr 45,00

## New Yanmar genuine parts

Rely on original

**Use only genuine Yanmar grease**

**Use only genuine Yanmar paint**

This paint is applicable for engines up to 500 HP and Yanmar gearboxes ZT350+SD series

## Service kit

Et service kit indeholder, hvad der skal bruges af oliefilter, brændstoffilter og impeller samt pakninger til disse til den årlige klargøring af din Yanmar motor.

Varenr.	Beskrivelse	Vejl. uds. incl. moms
SK-MARINE-001	1GM / 1GM10	kr 425,00
SK-MARINE-002	2GM / 2GM20 / 3GM / GMD / 3GM30	kr 537,50
SK-MARINE-003	2GMF / 3GMF / 2GM20F / 3GM30F	kr 750,00
SK-MARINE-004	3HM / 3HMF / 3HM35 / 3HM35F	kr 750,00
SK-MARINE-005	YM SERIE / 3GM20 / 3YM30 -YEU/2 GM20F/30F	kr 537,50
SK-MARINE-006	3JH2E / 3JH2T	kr 1.275,00
SK-MARINE-007	3JH3E / 3JH4E	kr 612,50
SK-MARINE-008	4JH-E / TE / THE / DTE / 4JH2-E / TE / 4JH2THE / DTE	kr 1.250,00
SK-MARINE-009	4JH2-UTE	kr 1.737,50
SK-MARINE-010	4JH3-E / 4JH4-E	kr 612,50
SK-MARINE-011	4JH3-TE / HTE / DTE / 4JH4-TE / 4JH4-THE	kr 962,50
SK-MARINE-012	4JH4-AE	kr 575,00
SK-8LV-001	8LV	kr 7.025,00



## Ombord kit

Ombordsæt for øget sikkerhed. Sættet indeholder et udvalg af del, som kan redde en weekend, hvis uheldet er ude.

Indeholder: impeller, kilerem, brændstoffilter, motorolie, brændstofslange, kølevandsslange, spændebånd o.s.v. i en vandtæt box.

Varenr.	Beskrivelse	Vejl. uds. incl. moms
OMBORDKIT 1GM10	1GM10	kr 1.637,50
OMBORDKIT 2YM15	2YM15	kr 1.750,00
OMBORDKIT 3YM	3YM20+30	kr 1.687,50
OMBORDKIT 3JH4	3JH4E	kr 1.925,00
OMBORDKIT 4JH4E	4JH4E	kr 1.925,00
OMBORDKIT 4JH4AE	4JH4AE	kr 1.950,00
OMBORDKIT 4JH4-TE	4JH4-TE	kr 2.150,00
OMBORDKIT 4JH4-HT	4JH4-HT	kr 2.350,00
OMBORDKIT BY	BY150/180/220/260	kr 3.500,00
OMBORDKIT BY-Z	BY150Z/180Z/220Z/260Z	kr 3.700,00
MACK726	YANMAR MARINE SMALL WATER PROF BOX	kr 243,75



## Elektronisk motor data udlæsning

Med dette sæt kan motorens analoge data-signaler forvandles til elektroniske data-signaler. Motorens data, som f.eks. smørelolie, vandtemperatur, motoromdrejning kan nu konverteres til NEMA 2000 data kommunikation og sendes til kompatible NEMA 2000 instrumenter som f.eks. Garmin, Ray Marine, etc.

Installation med dette kit er "plug and play" og kan ved bestilling blive forprogrammeret til Deres specifikke Yanmar motor model.

Kittet indeholder de nødvendige kabler, bortset fra tilslutningskablet til Deres specifikke instrument, hvor De ønsker data udlæsningen.

Varenr.	Beskrivelse	Vejl. uds. incl. moms
NMEA-YANMAR-Q	NMEA2000 KIT TIL YANMAR YM, JH, LHA, LP	kr 12.595,00
164000-17000-Q	CAN CONVERTER JH CR SERIE	kr 4.687,50





## Vandlås/dæmpere med drejbare studse

Varenr.	Beskrivelse	Vejl. uds. incl. moms
NLP45	FOR SLANGE Ø:45 mm KAPACITET 4,5 l	kr 1.600,00
NLP50	FOR SLANGE Ø:50 mm KAPACITET 4,5 l	kr 1.600,00
NLP75	FOR SLANGE Ø:76 mm KAPACITET 10 l	kr 2.340,00



## Udstødningsgennemføringer

Varenr.	Beskrivelse	Vejl. uds. incl. moms
TRC45SV	<b>LIGE</b> Ø1: 45 mm Ø2: 79 mm L: 75 mm	kr 690,00
TRC50SV	Ø1: 51 mm Ø2: 84 mm L: 75 mm	kr 700,00
TRC75SV	Ø1: 76 mm Ø2: 110 mm L: 90 mm	kr 1.010,00
TRC100SV	Ø1: 101 mm Ø2: 140 mm L: 115 mm	kr 1.530,00
TRC125SV	Ø1: 127 mm Ø2: 169 mm L: 140 mm	kr 2.790,00

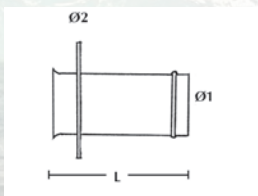

## Søvandsfiltre med holder

Varenr.	Beskrivelse	Vejl. uds. incl. moms
FTR140/13	13 mm KAPACITET: 23 ltr/min.	kr 670,00
FTR140/16	16 mm KAPACITET: 35 ltr/min.	kr 680,00
FTR140/19	19 mm KAPACITET: 51 ltr/min.	kr 680,00
FTR330/13	13 mm KAPACITET: 23 ltr/min.	kr 810,00
FTR330/16	16 mm KAPACITET: 35 ltr/min.	kr 810,00
FTR330/19	19 mm KAPACITET: 51 ltr/min.	kr 810,00
FTR330/25	25 mm KAPACITET: 91 ltr/min.	kr 810,00
FTR330/32	32 mm KAPACITET: 143 ltr/min.	kr 810,00



## Antihævertventil

Varenr.	Beskrivelse	Vejl. uds. incl. moms
AIRVENTV13-19-25-32 mm MED TRYKVENTIL		kr 810,00



## Slangeadapterer i nylon

Varenr.	Beskrivelse	Vejl. uds. incl. moms
HA1338	13-38 mm	kr 149,00
HA3060	30-60 mm	kr 189,00



## Udstødningsslanger

Meget flexibel udstødningsslange med stålspiral. Iso godkendt, Lloyd og Rina godkendt. -25°C - +120°C.

OBS !! SLANGER SÆLGES KUN I HELE METER

Varenr.	Beskrivelse	Vejl. uds. incl. moms
SLANG45	INDVENDIG Ø: 45 mm UDVENDIG Ø: 53 mm	kr 319,00
SLANG51	INDVENDIG Ø: 51 mm UDVENDIG Ø: 59 mm	kr 329,00
SLANG75	INDVENDIG Ø: 76 mm UDVENDIG Ø: 86 mm	kr 469,00
SLANG100	INDVENDIG Ø: 102 mm UDVENDIG Ø: 112 mm	kr 550,00
SLANG125	INDVENDIG Ø: 127 mm UDVENDIG Ø: 137 mm	kr 760,00



## Brændstovsslanger

Marine brændstovsslanger Iso 7840 klasse A1 -25C - +120C - 40°C

Varenr.	Beskrivelse	Vejl. uds. incl. moms
63412-8	Ø: 8 mm UDV.Ø:19 mm 40BAR	kr 65,00
63412-10	Ø:10 mm UDV.Ø 21 mm 40BAR	kr 75,00
63412-12	Ø:12 mm UDV.Ø:24 mm 40BAR	kr 95,00



## Kølevandsslanger

Gummislange med indstøbt stålspiral, sort - 40°C - +120°C

Varenr.	Beskrivelse	Vejl. uds. incl. moms
63418-12	Ø: 12 mm UDVENDIG Ø: 19 mm 6.BAR	kr 165,00/M
63418-16	Ø: 16 mm UDVENDIG Ø: 22 mm 6.BAR	kr 175,00/M
63418-19	Ø: 19 mm UDVENDIG Ø: 26 mm 6.BAR	kr 185,00/M
63418-25	Ø: 25 mm UDVENDIG Ø: 34 mm 6.BAR	kr 220,00/M



## Spændbånd RF A4

Syrefaste A4.

Varenr.	Beskrivelse	Vejl. uds. incl. moms
108426	Ø: 8-14 mm B: 8 mm	kr 28,00
108428	Ø: 13-20 mm B:12 mm	kr 28,00
108429	Ø: 15-24 mm B:12 mm	kr 30,00
108431	Ø: 22-32 mm B:12 mm	kr 30,00
108432	Ø: 26-38 mm B:12 mm	kr 30,00
108434	Ø: 38-50 mm B:12 mm	kr 33,00
108436	Ø: 50-65 mm B:12 mm	kr 33,00
108437	Ø: 58-75 mm B:12 mm	kr 35,00
108438	Ø: 68-85 mm B:12 mm	kr 38,00
108439	Ø: 77-95 mm B:12 mm	kr 43,00



## Spændbånd, heavy duty

Kraftige spændbånd, RF AISI 316 med Unbraco.

Varenr.	Beskrivelse	Vejl. uds. incl. moms
HCHDS051	Ø: 51 - 55 mm MED 2.STK.UNBRACO	kr 58,00
HCHDS059	Ø: 59 - 63 mm MED 2.STK.UNBRACO	kr 62,00
HCHDS085	Ø: 85 - 91 mm MED 2.STK.UNBRACO	kr 87,00
HCHDS112	Ø: 112 - 121 mm MED 2.STK.UNBRACO	kr 109,00
HCHDS130	Ø: 130 - 140 mm MED 2.STK.UNBRACO	kr 169,00





## Fittings

Messingfittings af høj kvalitet UNI EN 1982-CC491K.

### Skroggennemføringer

Varenr.	Beskrivelse	Vejl. uds. incl. moms
14020-12	1/2" GEVIND	kr 45,00
14020-18	3/4" GEVIND	kr 50,00
14020-25	1" GEVIND	kr 70,00
14020-31	1 1/4" GEVIND	kr 75,00
14020-36	1 1/2" GEVIND	kr 95,00



### Bundsi til skroggennemføringer

Varenr.	Beskrivelse	Vejl. uds. incl. moms
14019	TIL 3/4"	kr 110,00



### Kugleventiler

Varenr.	Beskrivelse	Vejl. uds. incl. moms
14039-12	TIL 1/2"	kr 65,00
14039-18	TIL 3/4"	kr 75,00
14039-25	TIL 1"	kr 120,00
14039-31	TIL 1 1/4"	kr 175,00
14039-36	TIL 1 1/2"	kr 265,00



### Bøjninger 90°

Indvendigt / udvendigt gevind.

Varenr.	Beskrivelse	Vejl. uds. incl. moms
14026-12	TIL 1/2"	kr 50,00
14026-18	TIL 3/4"	kr 65,00
14026-25	TIL 1"	kr 85,00
14026-31	TIL 1 1/4"	kr 120,00
14026-36	TIL 1 1/2"	kr 285,00



### Slangestudse

Varenr.	Beskrivelse	Vejl. uds. incl. moms
14025-12	R15 GEVIND 16 mm SLANGE	kr 45,00
14025-13	R15 GEVIND 19 mm SLANGE	kr 50,00
14025-17	R20 GEVIND 19 mm SLANGE	kr 65,00
14025-18	R20 GEVIND 25 mm SLANGE	kr 70,00
14025-24	R25 GEVIND 25 mm SLANGE	kr 75,00
14025-31	R32 GEVIND 38 mm SLANGE	kr 85,00
14025-37	R40 GEVIND 38 mm SLANGE	kr 95,00



### Brystripler

Varenr.	Beskrivelse	Vejl. uds. incl. moms
14033-12	1/2" GEVIND	kr 25,00
14033-18	3/4" GEVIND	kr 30,00
14033-25	1" GEVIND	kr 40,00
14033-31	1 1/4" GEVIND	kr 45,00
14033-36	1 1/2" GEVIND	kr 65,00



## Aksel systemer Klemflanger

Varenr.	Beskrivelse
SL-2543	25 mm. 4" GM/YM A:78,0 B:50,0 C:10,5 D:100

Vejl. uds. incl. moms
kr 2.325,00

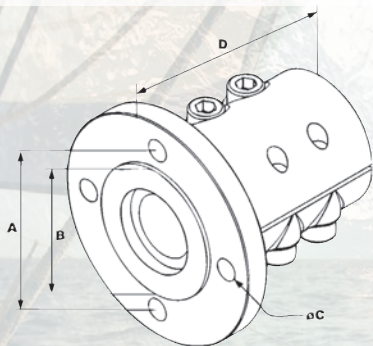

## Centa koblinger

Centa koblinger kan anvendes i stedet for traditionelle klemflanger. Centa koblingens funktion er absorbering af chock, vibrationer og frekvenser. Koblingen kræver ingen vedligeholdelse. Gummidelene bliver ikke slidte, hvilket sikrer lang levetid uden snavs fra gummidelene. Nedenstående koblinger er modeller tilpasset Yanmar motorer.

Varenr.	Beskrivelse	Vejl. uds. incl. moms
CFM127-K2.2Ø25	CFM127 Ø25 mm YM-Serie*	kr 3.063,75
CFM127-K2.2Ø30	CFM127 Ø30 mm	kr 3.063,75
CFM127-K2.2Ø35	CFM127 Ø35 mm	kr 3.063,75
CFM160-K2.2Ø25	CFM160 Ø25 mm 3JH4E*	kr 5.125,00
CFM160-K2.2Ø30	CFM160 Ø30 mm	kr 5.125,00
CFM160-K2.2Ø35	CFM160 Ø35 mm 4JH4E + 4JH4-TE*	kr 5.125,00
CFM160-K2.3Ø25	CFM160 Ø25 mm	kr 5.125,00
CFM160-K2.3Ø30	CFM160 Ø30 mm	kr 5.125,00
CFM160-K2.3Ø35	CFM160 Ø35 mm 4JH4-HTE*	kr 5.125,00
CFAM050-K1.0Ø25	CFAM050 Ø25 mm	kr 9.741,25
CFAM050-K1.0Ø30	CFAM050 Ø30 mm	kr 9.741,25
CFAM050-K1.0Ø35	CFAM050 Ø35 mm 4JH3-DTE*	kr 9.741,25
CFAM050-K2.3Ø25	CFMA050 Ø25 mm	kr 9.741,25
CFAM050-K2.3Ø30	CFMA050 Ø30 mm	kr 9.741,25
CFAM050-K2.3Ø35	CFMA050 Ø35 mm	kr 9.741,25
CFM-K-1.2-ADAPTOR-80	CENTA ADAPTOR BLA. TIL BY	kr 4.561,00

\* Minimumsdimension anbefalet af Yanmar





## Propelaksler

Aksler leveres i stålqualitet S165M.

Varenr.	Beskrivelse	Vejl. uds. incl. moms
SA-15250	25 mm X 1,5 m ISO KONUS 1:10	kr 2.400,00
SA-20250	25 mm X 2,0 m ISO KONUS 1:10	kr 3.200,00
SA-25250	25 mm X 2,5 m ISO KONUS 1:10	kr 4.125,00

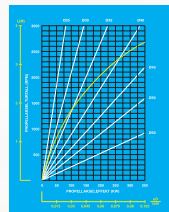
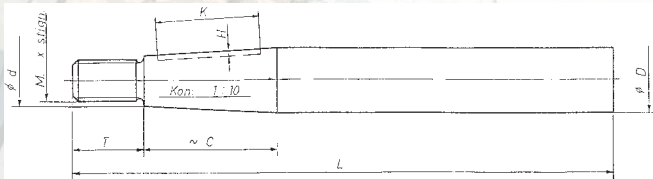

## Akseltætning

Varenr.	Beskrivelse	Vejl. uds. incl. moms
4900825	AKSELPAKBOX TIL Ø: 25 mm	kr 715,00
4900830	AKSELPAKBOX TIL Ø: 30 mm	kr 780,00
4900835	AKSELPAKBOX TIL Ø: 35 mm	kr 1.025,00
4900840	AKSELPAKBOX TIL Ø: 40 mm	kr 1.120,00
4900845	AKSELPAKBOX TIL Ø: 45 mm	kr 1.240,00
4900850	AKSELPAKBOX TIL Ø: 50 mm	kr 1.390,00

øD	ød	Mx	T	C	K	H	b*
25	19,7	16x1,5	25	53	46	3,5	6
30	22,9	20x1,5	30	71	57	4	8
35	26,9	24x2	35	81	64	5	10
40	30,9	24x2	40	91	81	5	12
45	30,9	33x2	45	101	91	5,5	14
50	39,0	36x3	50	111	91	5,5	14
60	46,5	45x3	60	135	112	7	18

\*Bredde kilespor



## 2-bladet Gori foldepropel for akselinstallation

ISO eller SAE standard-konus, notgang og møtrik uden merpris. Special-konus, efter mål, mod merpris på kr 500,-

Diameter x Stigning	Beskrivelse	Vejl. uds. incl. moms
11,5" x 8"	RH/LH	kr 6.200,00
11,5" x 9,5"	RH KUN SOM HØJREDREJ	kr 6.200,00
12,5" x 8"	RH KUN SOM HØJREDREJ	kr 6.200,00
13" x 9"	RH/LH	kr 6.500,00
14" x 9,5"	RH/LH	kr 6.500,00
15" x 10"	RH/LH	kr 6.700,00
15" x 12"	RH/LH	kr 6.700,00
16,5" x 11"	RH/LH	kr 7.200,00
16,5" x 13"	RH/LH	kr 7.200,00
18" x 13"	RH/LH	kr 7.750,00
18" x 15"	RH/LH	kr 7.750,00



## 2-bladet Gori foldepropel for sejl-drev

Diameter x Stigning	Beskrivelse	Vejl. uds. incl. moms
11,5" X 8"	RHS BUKH DV8 SME	kr 7.100,00
11,5" X 9,5"	RHS BUKH DV10 LSME	kr 7.100,00
12" X 8"	RHS BUKH DV10 LSME	kr 7.200,00
12,5" X 8"	RHS BUKH DV10 LSME	kr 7.200,00
11,5" X 8"	RHS VP MB 2A 50S	kr 7.200,00

Yanmar, Volvo, Bukh, Lombardini, Nanni mfl\*

13" X 9"	LHS KUN SOM VENSTREDREJ	kr 8.400,00
14" X 9,5"	LHS KUN SOM VENSTREDREJ	kr 8.600,00
15" X 10"	LHS KUN SOM VENSTREDREJ	kr 8.700,00
15" X 11"	LHS KUN SOM VENSTREDREJ	kr 8.700,00
15" X 12"	LHS KUN SOM VENSTREDREJ	kr 8.700,00
16,5" X 11"	LHS KUN SOM VENSTREDREJ	kr 8.800,00
16,5" X 13"	LHS KUN SOM VENSTREDREJ	kr 8.800,00
18" X 11"	LHS KUN SOM VENSTREDREJ	kr 8.950,00
18" X 12"	LHS KUN SOM VENSTREDREJ	kr 8.950,00
18" X 13"	LHS KUN SOM VENSTREDREJ	kr 8.950,00

\* Sejl-drevs propeller er inkl. tære-zink monteret på navet.

For Volvo 100S sejl-drevs propeller er der et pristillæg på kr 625,-  
Bemærk at der på Volvo 100S er et gab på ca 10 mm mellem propel og sejl-drev.

**Brug beregningssystemet på [www.gori-propeller.dk](http://www.gori-propeller.dk) for beregning af propeller.**





## 3-bladet Gori foldepropel for sejl-drev

Fås også som singlespeed uden overdrive.

Diameter x Stigning	Beskrivelse	Vejl. uds. incl. moms
15" x 9"	RHS/LHS	kr 18.800,00
15" x 10"	RHS/LHS	kr 18.800,00
15" x 11"	RHS/LHS	kr 18.800,00
15" x 12"	RHS/LHS	kr 18.800,00
16,5" x 10"	RHS/LHS	kr 19.600,00
16,5" x 11"	RHS/LHS	kr 19.600,00
16,5" x 12"	RHS/LHS	kr 19.600,00
16,5" x 13"	RHS/LHS	kr 19.600,00
18" x 11"	RHS/LHS	kr 24.200,00
18" x 12"	RHS/LHS	kr 24.200,00
18" x 13"	RHS/LHS	kr 24.200,00
18" x 14"	RHS/LHS	kr 24.200,00
20" x 12"	RHS/LHS	kr 25.200,00
20" x 13"	RHS/LHS	kr 25.200,00
20" x 14"	RHS/LHS	kr 25.200,00
20" x 15"	RHS/LHS	kr 25.200,00
20" x 16"	RHS/LHS	kr 25.200,00

Fås også  
som single-  
speed

Brug beregningssystemet på [www.gori-propeller.dk](http://www.gori-propeller.dk) for beregning af propeller.

### For sejl



### Fremad



### Baglæns

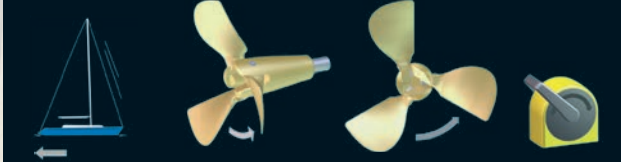

### Fremad "overdrive"



## 3-bladet Gori foldepropel for akselinstallation

ISO eller SAE standard-konus, notgang og møtrik uden merpris. Special-konus, efter mål, mod merpris på kr 500,-

Fås også som singlespeed uden overdrive.

Diameter x Stigning	Beskrivelse	Vejl. uds. incl. moms
15" x 9"	RH/LH	kr 17.950,00
15" x 10"	RH/LH	kr 17.950,00
15" x 11"	RH/LH	kr 17.950,00
15" x 12"	RH/LH	kr 17.950,00
16,5" x 10"	RH/LH	kr 18.950,00
16,5" x 11"	RH/LH	kr 18.950,00
16,5" x 12"	RH/LH	kr 18.950,00
16,5" x 13"	RH/LH	kr 18.950,00
18" x 11"	RH/LH	kr 23.450,00
18" x 12"	RH/LH	kr 23.450,00
18" x 13"	RH/LH	kr 23.450,00
18" x 14"	RH/LH	kr 23.450,00
20" x 12"	RH/LH	kr 24.500,00
20" x 13"	RH/LH	kr 24.500,00
20" x 14"	RH/LH	kr 24.500,00
20" x 15"	RH/LH	kr 24.500,00
20" x 16"	RH/LH	kr 24.500,00
22" x 13"	RH/LH	kr 31.000,00
22" x 14"	RH/LH	kr 31.000,00
22" x 15"	RH/LH	kr 31.000,00
22" x 16"	RH/LH	kr 31.000,00
22" x 17"	RH/LH	kr 31.000,00
24" x 15"	RH/LH	kr 32.900,00
24" x 16"	RH/LH	kr 32.900,00
24" x 17"	RH/LH	kr 32.900,00
24" x 18"	RH/LH	kr 32.900,00
24" x 19"	RH/LH	kr 32.900,00
26" x 16"	RH/LH	kr 37.100,00
26" x 17"	RH/LH	kr 37.100,00
26" x 18"	RH/LH	kr 37.100,00
26" x 19"	RH/LH	kr 37.100,00
26" x 20"	RH/LH	kr 37.100,00
26" x 21"	RH/LH	kr 37.100,00
28" x 17" - 23"	RH/LH	kr 62.000,00
30" x 18" - 24"	RH/LH	kr 65.500,00

Fås også  
som single-  
speed

Brug beregningssystemet på [www.gori-propeller.dk](http://www.gori-propeller.dk) for beregning af propeller.





## Trekantet ende-zink incl. skruer & låselim

Varenr.	Beskrivelse	Vejl. uds. incl. moms
1407210000	ZINKANODE SÆT TIL Ø: 15" - 16,5" 3 BL.	kr 150,00
1407310000	ZINKANODE SÆT TIL Ø: 18" - 20" 3BL	kr 150,00
1407410000	ZINKANODE SÆT TIL Ø: 22" - 26" 3BL	kr 150,00
1407451100	ZINKANODE SÆT TIL Ø: 28" - 30" 3BL	kr 200,00



## Trekantet ende-zink incl. skruer, låselim & stoppers

Varenr.	Beskrivelse	Vejl. uds. incl. moms
1472100000	ZINKANODE/GUMMIPROPPER TIL Ø: 15" - 16,5" 3 BL	kr 350,00
1473510000	ZINKANODE/GUMMIPROPPER TIL Ø: 18" - 20" 3 BL	kr 350,00
1474610000	ZINKANODE/GUMMIPROPPER TIL Ø: 22" - 26" 3 BL	kr 350,00
1412610000	ZINKANODE/GUMMIPROPPER TIL Ø: 28" - 30" 3 BL	kr 540,00



## Stoppers

Varenr.	Beskrivelse	Vejl. uds. incl. moms
1407710000	GUMMIPROPSÆT TIL Ø: 15" - 16,5" 3.B	kr 263,00
1407510000	GUMMIPROPSÆT TIL Ø: 18" - 20" 3BL	kr 263,00
1407610000	GUMMIPROPSÆT TIL Ø: 22" - 26" 3BL	kr 263,00
1409710000	GUIPROPSÆT TIL Ø: 28" - 30" 3BL	kr 460,00



## Zink-ring incl. skruer & lim

Varenr.	Beskrivelse	Vejl. uds. incl. moms
1567000000	ZINK-RING SÆT TIL NAV 110S Ø: 13" - 18" 2.BL	kr 320,00
1552000000	ZINK-RING SÆT TIL NAV. Ø: 15" - 16,5" 3 BL.	kr 320,00
1553000000	ZINK-RING SÆT TIL NAV. Ø: 18" - 20" 3 BL.	kr 320,00
1554000000	ZINK-RING SÆT TIL NAV. Ø: 22" - 26" 3 BL.	kr 400,00
1555000000	ZINK-RING SÆT TIL NAV. Ø: 28" - 30" 3BL.	kr 500,00
1552750000	ZINK-RING SÆT TIL SD Ø: 15" - 16,5" 3BL.SEJLDREVSPROPEL	kr 320,00
1553950000	ZINK-RING SÆT TIL SD Ø: 18" - 20" 3 BL.SEJLDREVSPROPEL	kr 320,00



## Hagenøgle og aftrækker

Varenr.	Beskrivelse	Vejl. uds. incl. moms
1444000000	GORI HAGENØGLE 15" -16,5" 3B (Hub 75)AMF 1810B 68-75 mm	kr 187,50
1406700000	GORI HAGENØGLE 18" -20" (Hub 95)AMF 1810B 95-100 mm	kr 250,00
1406300000	GORI HAGENØGLE 22" -26" (Hub 110)	kr 375,00
1409800000	GORI HAGENØGLE 28" -30" (Hub 140)	kr 500,00
1526000000	GORI AFTRÆKKER 15" -16,5" (Hub 75)	kr 325,00
1527000000	GORI AFTRÆKKER 18" -20" (Hub 95)	kr 375,00
1528000000	GORI AFTRÆKKER 22" -26" (Hub 110)	kr 500,00
1529000000	GORI AFTRÆKKER 28" -30" (Hub 140)	kr 625,00

## Zink og stoppers



ø13"-18" #1567000000



**2-bladed  
sejldrev**



ø15"-16,5" #1552000000  
 ø18"-20" #1553000000  
 ø22"-26" #1554000000  
 ø28"-30" #1555000000



**3-bladede  
aksler**



ø15"-16,5" #1407710000  
 ø18"-20" #1407510000  
 ø22"-26" #1407610000  
 ø28"-30" #1409710000

+



ø15"-16,5" #1407210000  
 ø18"-20" #1407310000  
 ø22"-26" #1407410000  
 ø28"-30" #1407451100

=



ø15"-16,5" #1472100000  
 ø18"-20" #1473510000  
 ø22"-26" #1474610000  
 ø28"-30" #1412610000



ø15"-16,5" #15527500  
 ø18"-20" #15539500

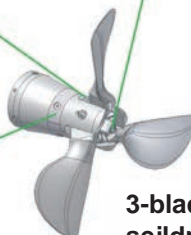

**3-bladede  
sejldrev**



## Gas- & gearboks TFX

Gear- og gasreguleringsboks fra Teleflex.

Boksene fås i forskellige design afhængig af hvilken bådtype, de skal anvendes til. Boksene er designet til brug for fritidsfartøjer, og er i en høj kvalitet, som sikrer lang levetid.

OBS ! Alle bokse leveres uden kabler.

Varenr.	Beskrivelse	Vejl. uds. incl. moms
CO-281603	700/SS SIDEMONT. ETGREBSBOKS MED SEJLBÅDSHÅNDTAG ANVENDER 2 STK. CC233/CC3300/CC633 KABLER	kr 1.630,00
CO-281602	700/SM SIDEMONT. ETGREBSBOKS MED SEJLBÅDSHÅNDTAG ANVENDER 2 STK. CC233/CC3300/CC633 KABLER	kr 1.770,00
CO-281607	700/SMT SIDEMONT. ETGREBSBOKS MED SEJLBÅDSHÅNDTAG MED TRIMKONTAKT. ANVENDER 2 STK. CC233/CC3300/CC633 KABLER	kr 2.449,00
CO-281645	CH2850 SIDEMONT. ETGREBSBOKS FOR SEJL- ELLER MOTORBÅDE HÅNDTAG I RF.ST. ANVENDER 2 STK. CC3300/CC633 KABLER	kr 2.094,00
CO-281644	CH2800 SAMME SOM CH2850 MED TRIMKONTAKT I HÅNDTAG ANVENDER 2 STK. CC3300/CC633 KABLER	kr 2.703,00
CO-281620	MT3 ENKELT TOPMONT. ETGREBSBOKS FOR ÉN MOTOR HUS & HÅNDTAG I FORCROMET BRONZE. ANVENDER 2 STK. CC3300/CC633 KABLER	kr 2.639,00
CO-281622	MT3 DOBBELT TOPMONT. ETGREBSBOKS FOR ÉN MOTOR. HUS & HÅNDTAG I FORCROMET BRONZE. ANVENDER 4 STK. CC3300/CC633 KABLER	kr 5.564,00
CO-281600	700/TS ENKELT TOPMONT. ETGREBSBOKS FOR ÉN MOTOR. HUS & HÅNDTAG I PLAST/METAL. ANVENDER 2 STK. CC233/CC3300/CC633 KABLER	kr 2.015,00
CO-281605	700/TST SAMME SOM 700/TS MED TRIMKONTAKT I HÅNDTAG ANVENDER 2 STK. CC233/CC3300/CC633 KABLER	kr 2.577,00
CO-281601	700/TD DOBBELT TOPMONT. ETGREBSBOKS FOR TO MOTORER HUS & HÅNDTAG I PLAST/METAL. ANVENDER 4 STK. CC233/CC3300/CC633 KABLER	kr 3.952,00
CO-281629	SL3 ENKELT TOPMONT. ETGREBSBOKS FOR TO MOTORER. MED NEUTRAL, DER FORHINDRER START AF MOTOR I GEAR. ANVENDER 2 STK. CC233/CC3300/CC633 KABLER	kr 2.881,00
CO-281630	SL3 ENKELT TOPMONT. MED TRIM SAMME SOM SL3 MED TRIMKONTAKT I HÅNDTAG. ANVENDER 2 STK. CC233/CC3300/CC633 KABLER	kr 3.079,00
CO-281635	SL3 DOBBELT TOPMONT ETGREBSBOKS FOR TO MOTORER. MED NEUTRAL, DER FORHINDRER START AF MOTOR I GEAR. ANVENDER 4 STK. CC233/CC3300/CC633 KABLER	kr 5.281,00
CO-281636	SL3 DOBBELT TOPMONT MED TRIM. SAMME SOM SL3 DOBBELT MED TRIM/TILT KONTAKT I HÅNDTAG. ANVENDER 4 STK. CC233/CC3300/CC633 KABLER	kr 6.117,00
CO-281648	700T TROLLING. BRUGES TIL REGULERING AF TROLLING-VENTIL PÅ HYDRAULISKE GEAR. ANVENDER 1 STK. CC233/CC3300/CC633 KABEL	kr 1.793,00



CO-281603



CO-281602



CO-281645



CO-281620



CO-281622



CO-281600



CO-281635



CO-281629



CO-281601



CO-281648

## Reservedele TFX bokse



CO-281613



CO-281610



CO-281611



CO-281615

Varenr.	Beskrivelse	Vejl. uds. incl. moms
CO-281613	700/SS MONT.SÆT BEST.AF HÅNDTAG,PLADE & KNAP	kr 490,00
CO-281610	700/TS MONT.SÆT BEST.AF HÅNDTAG & DÆKSEL	kr 967,00
CO-281611	700/TD MONT.SÆT BEST.AF HÅNDTAG & DÆKSEL	kr 1.909,00
CO-281615	B700 MEKANISK GAS/GEARBOKS, STANDARD MEKANISME I ALLE TFX BOKSE	kr 1.030,00

## Diverse dele



CO-281617



CO-281618



CO-281623



CO-281624

Varenr.	Beskrivelse	Vejl. uds. incl. moms
CO-281617	SORT KNAP T/ 700/SM, 700/TS, 700/TD	kr 40,00
CO-281618	RØD KNAP T/700/SS, 700T	kr 9,00
CO-281623	RØD KUGLE	kr 84,00
CO-281624	SORT KUGLE	kr 84,00
CO-281705	KABEL KONNEKTOR	kr 75,00



CO-281705



## Teleflex reguleringskabler CC3300 gas- & gearkabler

Standard kontrolkabel til gas og gear. Kraftig yderbeklædning gør dette kabel velegnet til indenbordsmotorer og installationer, hvor der kræves lange kabler. Slaglængde: 75 mm. Massiv indertråd i rustfrit stål. Gevind: 10/32" UNF (5 mm). Mindste bøjningsradius: 200 mm. Leveres fra 1,0 m - 20,0 m ( 25 cm interval).

Svarer til: TFX F303, Morse 33C, U-FLEX C8

Varenr.	Beskrivelse	Vejl. uds. incl. moms
101041	GAS/GEAR KABEL L: 5 fod 153 cm	kr 160,00
101042	GAS/GEAR KABEL L: 6 fod 183 cm	kr 165,00
101043	GAS/GEAR KABEL L: 7 fod 213 cm	kr 170,00
101044	GAS/GEAR KABEL L: 8 fod 244 cm	kr 175,00
101045	GAS/GEAR KABEL L: 9 fod 274 cm	kr 180,00
101046	GAS/GEAR KABEL L: 10 fod 305 cm	kr 190,00
101048	GAS/GEAR KABEL L: 11 fod 335 cm	kr 195,00
101049	GAS/GEAR KABEL L: 12 fod 366 cm	kr 200,00
101050	GAS/GEAR KABEL L: 13 fod 396 cm	kr 205,00
101051	GAS/GEAR KABEL L: 14 fod 427 cm	kr 210,00
101052	GAS/GEAR KABEL L: 15 fod 457 cm	kr 215,00
101053	GAS/GEAR KABEL L: 16 fod 488 cm	kr 220,00
101054	GAS/GEAR KABEL L: 17 fod 518 cm	kr 225,00
101055	GAS/GEAR KABEL L: 18 fod 549 cm	kr 230,00
101056	GAS/GEAR KABEL L: 19 fod 579 cm	kr 235,00
101057	GAS/GEAR KABEL L: 20 fod 610 cm	kr 240,00
101058	GAS/GEAR KABEL L: 21 fod 640 cm	kr 245,00
101059	GAS/GEAR KABEL L: 22 fod 671 cm	kr 255,00
101060	GAS/GEAR KABEL L: 23 fod 701 cm	kr 265,00
101061	GAS/GEAR KABEL L: 24 fod 732 cm	kr 270,00



## CC2300 gas- & gearkabler

Standard kontrolkabel til gas og gear. Meget fleksibelt kabel, velegnet til mindre både. Slaglængde: 75 mm. Massiv indertråd i rustfrit stål. Gevind: 10/32" unf (5 mm). Mindste bøjningsradius: 175 mm. Leveres fra 1,0 m - 5,0 m (25 cm interval).

Svarer til: TFX F203, Uflex C2

Varenr.	Beskrivelse	Vejl. uds. incl. moms
101120	GAS/GEAR KABEL L: 6 fod 183 cm	kr 160,00
101121	GAS/GEAR KABEL L: 7 fod 213 cm	kr 165,00
101124	GAS/GEAR KABEL L: 10 fod 305 cm	kr 180,00
101126	GAS/GEAR KABEL L: 12 fod 366 cm	kr 190,00
101127	GAS/GEAR KABEL L: 13 fod 396 cm	kr 195,00
101129	GAS/GEAR KABEL L: 15 fod 457 cm	kr 200,00
101130	GAS/GEAR KABEL L: 16 fod 488 cm	kr 205,00



## CC633 extreme gas- & gearkabler

De-luxe kontrollkabel hvor inderwiren er nylonovertrukket. Dette medfører mærkbart mindre friktion både ved korte og meget lange kabellængder. Slaglængde: 75 mm. Flertrådet inderwire i rustfrit stål. Gevind: 10/32" UNF ( 5 mm ). Mindste bøyningsradius: 100 mm.  
Leveres i fod fra 5 - 50 fod (1 fods interval).  
Svarer til: U-Flex CMO

Varenr.	Beskrivelse	Vejl. uds. incl. moms
101676	GAS/GEAR KABEL 6 fod 183 cm	kr 250,00
101677	GAS/GEAR KABEL 7 fod 213 cm	kr 250,00
101678	GAS/GEAR KABEL 8 fod 244 cm	kr 255,00
101680	GAS/GEAR KABEL 9 fod 274 cm	kr 270,00
101681	GAS/GEAR KABEL 10 fod 305 cm	kr 265,00
101682	GAS/GEAR KABEL 11 fod 335 cm	kr 280,00
101683	GAS/GEAR KABEL 12 fod 366 cm	kr 290,00
101684	GAS/GEAR KABEL 13 fod 396 cm	kr 295,00
101685	GAS/GEAR KABEL 14 fod 427 cm	kr 310,00
101686	GAS/GEAR KABEL 15 fod 457 cm	kr 320,00
101687	GAS/GEAR KABEL 16 fod 488 cm	kr 325,00
101688	GAS/GEAR KABEL 17 fod 518 cm	kr 330,00
101689	GAS/GEAR KABEL 18 fod 549 cm	kr 340,00
101690	GAS/GEAR KABEL 19 fod 579 cm	kr 345,00
101691	GAS/GEAR KABEL 20 fod 610 cm	kr 360,00
101693	GAS/GEAR KABEL 22 fod 671 cm	kr 380,00
101695	GAS/GEAR KABEL 24 fod 732 cm	kr 395,00
101696	GAS/GEAR KABEL 25 fod 762 cm	kr 410,00





# Elektronisk Micro Comander motorreguleringssystem

Elektronisk motorregulering kan erstatte traditionelle motorinstallationer med stive gear- og gas- kabelinsatationer. Her vises et eksempel på en komplet installationspakke til en motor og et styrested.

Indeholder: Micro Comander styreboks, APS, Standard kontrol håndtag, 20 meter kontrol kabel og 5 meter powerkabel.



Beskrivelse  
MICROCOMANDER SÆT PRIS

Vejl. uds. incl. moms  
kr 27.590,00

## Styreboks

Varenr.	Beskrivelse	Vejl. uds. incl. moms
91100	MICRO COMMANDER MED 1 UDGANG	kr 19.862,50
91102	MICRO COMMANDER MED 2 UDGANGE MED STIK	kr 22.250,00
91202	CLEAR COMMANDER	kr 21.425,00

## Enkeltgrebs håndtag

Varenr.	Beskrivelse	Vejl. uds. incl. moms
453-3L	KONTROLHÅNDTAG, ENKELT, VENSTRE	kr 3.250,00
453-3R	KONTROLHÅNDTAG, ENKELT, HØJRE	kr 3.250,00
456-3L	KONTROLHÅNDTAG, ENKELT, VENSTRE	kr 3.775,00
456-3R	KONTROLHÅNDTAG, ENKELT, HØJRE	kr 3.775,00
450-3L	KONTROLHÅNDTAG, ENKELT, VENSTRE	kr 2.537,50
450-3R	KONTROLHÅNDTAG, ENKELT, HØJRE	kr 2.537,50
MC2000-1L	KONTROLHÅNDTAG, ENKELT, VENSTRE	kr 7.625,00
MC2000-1R	KONTROLHÅNDTAG, ENKELT, HØJRE	kr 7.625,00
MC2000-2L	KONTROLHÅNDTAG, ENKELT, HØJRE CHROME	kr 8.350,00
MC2000-2R	KONTROLHÅNDTAG, ENKELT, HØJRE CHROME	kr 8.350,00
MC2000-4L	KONTROLHÅNDTAG, ENKELT, VENSTRE	kr 7.750,00
MC2000-4R	KONTROLHÅNDTAG, ENKELT, HØJRE	kr 7.750,00
750-L	KONTROLHÅNDTAG, ENKELT, VENSTRE VANDTÆT	kr 17.950,00
750-R	KONTROLHÅNDTAG, ENKELT, HØJRE CHROME	kr 17.950,00



453-3L

## Dobbeltgrebs håndtag

Varenr.	Beskrivelse	Vejl. uds. incl. moms
463-4	KONTROLHÅNDTAG	kr 5.412,50
466-4	KONTROLHÅNDTAG	kr 6.437,50
460-4	KONTROLHÅNDTAG	kr 3.887,50
MC2000-1	KONTROLHÅNDTAG, SORT	kr 9.337,50
MC2000-2	KONTROLHÅNDTAG, CHROME	kr 10.725,00
MC2000-4	KONTROLHÅNDTAG	kr 9.537,50
760	KONTROLHÅNDTAG, VANDTÆT, DOBBEL	kr 24.175,00



MC2000-1

## Tilbehør

Varenr.	Beskrivelse	Vejl. uds. incl. moms
13505	AUTOMATIC POWER SELECTOR	kr 1.612,50

## Kabler for kontrol håndtag

Varenr.	Beskrivelse	Vejl. uds. incl. moms
13557-10	3 METER KONTROL KABEL	kr 787,50
13557-20	6 METER KONTROL KABEL	kr 962,50
13557-30	10 METER KONTROL KABEL	kr 1.137,50
13557-50	16 METER KONTROL KABEL	kr 1.487,50
13557-60	20 METER KONTROL KABEL	kr 1.662,50
13756-15	5 METER POWER KABEL	kr 1.190,00



MC2000-2

## Inverter - 230VAC 50Hz Sinus

Varenr.	Beskrivelse	Vejl. uds. incl. moms
28010300	AC MASTER 12/300 UNIVERSAL OUTPUT	kr 1.687,50
28010500	AC MASTER 12/500 UNIVERSAL OUTPUT	kr 2.162,50
28020300	AC MASTER 12/300 UNIVERSAL OUTPUT	kr 1.687,50
28020500	AC MASTER 12/500 UNIVERSAL OUTPUT	kr 2.162,50
28010700	AC MASTER 12/700 SCHUKO	kr 3.701,25
28020700	AC MASTER 24/700 SCHUKO	kr 3.701,25
28011000	AC MASTER 12/1000 SCHUKO	kr 4.725,00
28021000	AC MASTER 24/1000 SCHUKO	kr 4.725,00
28011500	AC MASTER 12/1500 SCHUKO	kr 7.065,00
28021500	AC MASTER 24/1500 SCHUKO	kr 7.065,00
28012500	AC MASTER 12/2500 SCHUKO/FAST TILSLUTNING	kr 11.916,25
28022500	AC MASTER 24/2500 SCHUKO/FAST TILSLUTNING	kr 11.916,25
28013500	AC MASTER 12/3500 SCHUKO/FAST TILSLUTNING	kr 15.712,50
21010800	MASS SINE 12/800	kr 7.276,25
24011200	MASS SINE 12/1200	kr 10.050,00
24012000	MASS SINE 12/2000	kr 15.638,75
24020800	MASS SINE 24/800	kr 7.445,00
24021500	MASS SINE 24/1500	kr 11.673,50
24022500	MASS SINE 24/2500	kr 20.480,00
24095100	MASS SINE 24/5000	kr 35.559,00



## Tilbehør Remote monitoring & options

Varenr.	Beskrivelse	Vejl. uds. incl. moms
77030700	MASTERBUS INVERTER INTERFACE	kr 1.645,00
70404110	MASTERLINK/C4-RI, ON/OFF INVERTER	kr 633,00
70403105	MASTERLINK/MICC, INCL SHUNT	kr 5.844,00



## Combi inverter / lader 230VAC 50/60Hz Mass Combi Pro Serie 230 V, 50/60Hz

Varenr.	Beskrivelse	Vejl. uds. incl. moms
38513000	MASS COMBI PRO 12/3000-150	kr 25.556,00
38523500	MASS COMBI PRO 24/3500-100	kr 18.187,00

## Mass Combi Ultra Serie 230 V, 50/60Hz

Varenr.	Beskrivelse	Vejl. uds. incl. moms
38013000	MASS COMBI ULTRA 12/3000-150	kr 28.187,00
38023500	MASS COMBI ULTRA 24/3500-100	kr 31.446,00
38343500	MASS COMBI ULTRA 48/3500-50 (NO SOLAR INPUT)	kr 31.446,00





# Mass Combi series (NEW RANGE) 230 V, 50/60Hz

Varenr.	Beskrivelse	Vejl. uds. incl. moms
36011600	MASS COMBI 12/1600-60	kr 15.153,50
36011601	MASS COMBI 12/1600-60 INCL. ICC & APC (36011600 + 70405000 + 70405010)	kr 16.240,00
36011602	MASS COMBI 12/1600-60 INCL. MASTERBUS COMBI INTERFACE (36011600 + 77030475)	kr 16.514,00
36012200	MASS COMBI 12/2200-100	kr 20.036,25
36012201	MASS COMBI 12/2200-100 INCL. ICC & APC (36012200 + 70405000 + 70405010)	kr 21.122,50
36012202	MASS COMBI 12/2200-100 INCL. MASTERBUS COMBI INTERFACE (36012200 + 77030475)	kr 21.396,25
36021800	MASS COMBI 24/1800-35	kr 17.326,25
36021801	MASS COMBI 24/1800-35 INCL. ICC & APC (36021800 + 70405000 + 70405010)	kr 17.412,50
36021802	MASS COMBI 24/1800-35 INCL. MASTERBUS COMBI INTERFACE (36021800 + 77030475)	kr 18.686,25
36022600	MASS COMBI 24/2600-60	kr 21.670,00
36022601	MASS COMBI 24/2600-60 INCL. ICC & APC (36022600 + 70405000 + 70405010)	kr 22.756,25
36022602	MASS COMBI 24/2600-60 INCL. MASTERBUS COMBI INTERFACE (36022600 + 77030475)	kr 23.031,25
77712200	COMFORTSYSTEM COMBI 12/2200, MASTERSHUNT, DC DISTRI, EASY, 16A SHORE CABLE + INLET	kr 29.812,00



## Remote monitoring & options

Varenr.	Beskrivelse	Vejl. uds. incl. moms
77010305	MASTERVIEW EASY – 3,5" TOUCH SCREEN TO MONITOR ONE OR MORE MASTERBUS PRODUCTS	kr 3.049,00
77010310	MASTERVIEW EASY – 5" TOUCH SCREEN TO MONITOR ONE OR MORE MASTERBUS PRODUCTS	kr 3.394,00
<b>• MASS COMBI ULTRA, PRO &amp; MASS SINE ULTRA SERIES</b>		
6502000010	COMM / SYNC CABLE (RJ12) 1 METRE	kr 71,00
6202000030	COMM / SYNC CABLE (RJ12) 3 METRE	kr 107,00
6202001030	COMM / SYNC CABLE (RJ12) 6 METRE	kr 113,00
6502100100	COMM / SYNC CABLE (RJ12) 10 METRE	kr 153,00
6502100150	COMM / SYNC CABLE (RJ12) 15 METRE	kr 184,00
<b>• MASS COMBI SERIES</b>		
70405000	REMOTE PANEL ICC (STANDARD FOR 2 KW & 4 KW MODELS)	kr 1.979,00
70405010	REMOTE PANEL APC (WITH POWER SHARING)	kr 2.002,00
70405050	REMOTE PANEL APC (WITH POWER SHARING), FOR 120 V MODELS	kr 2.002,00
70403105	MASTERLINK/MICC, INCL. SHUNT	kr 5.844,00
130010905	MASS COMBI CABLE FOR MASTER/SLAVE PARALLEL OPERATION, 1 METER	kr 83,00
77030450	MASTERBUS SERIAL INTERFACE (FOR COMBI INSTALLATIONS WITH MASTERSHUNT)	kr 1.645,00
77030475	MASTERBUS COMBI INTERFACE (FOR COMBI INSTALLATIONS WITHOUT MASTERSHUNT)	kr 2.220,00



# Batteri laderer Microprocessor controlled IP20

## Universal input 90-265V AC/45-65Hz, (Startstrøms beskyttet)

Varenr.	Beskrivelse	Vejl. uds. incl. moms
43510100	MASTERVOLT EASYCHARGE PORTABLE 1.1A	kr 536,00
43510400	MASTERVOLT EASYCHARGE PORTABLE 4.3A	kr 581,00
43310600	EASYCHARGE 6A-1 IP65	kr 902,00
43321000	EASYCHARGE 10A-2 IP65	kr 1.360,00

### CHARGEMASTER SERIEN • 90-265 V, 50 & 60 HZ (STARTSTRØMS BESKYTTET)

Varenr.	Beskrivelse	Vejl. uds. incl. moms
44010250	CHARGEMASTER 12/25-3	kr 5.157,00
44010500	CHARGEMASTER 12/50-3	kr 6.738,00
44010700	CHARGEMASTER 12/70-3	kr 10.187,00
44011000	CHARGEMASTER 12/100-3	kr 13.181,00
44020120	CHARGEMASTER 24/12-3	kr 3.585,00
44020200	CHARGEMASTER 24/20-3	kr 5.051,00
44020300	CHARGEMASTER 24/30-3	kr 6.622,00
44020400	CHARGEMASTER 24/40-3	kr 9.016,00
44020600	CHARGEMASTER 24/60-3	kr 10.788,00
44020800	CHARGEMASTER 24/80-3	kr 15.607,00
44021000	CHARGEMASTER 24/100-3	kr 20.194,00
44310750	CHARGEMASTER PLUS 12/75-3	kr 9.174,00
44311000	CHARGEMASTER PLUS 12/100-3	kr 11.863,00
44320400	CHARGEMASTER PLUS 24/40-3	kr 8.120,00
44320600	CHARGEMASTER PLUS 24/60-3	kr 9.702,00

### MASS SERIEN • 230 V, 50 & 60 HZ (INCL. LADE STATUS INTERFACE)

Varenr.	Beskrivelse	Vejl. uds. incl. moms
40020156	MASS 24/15-2	kr 8.531,00
40020256	MASS 24/25-2	kr 9.079,00
40720266	MASS 24/25-2, INCL. DNV CERTIFICATION	kr 11.747,00
40020506	MASS 24/50-2, INCL. DNV CERTIFICATION	kr 12.844,00
40020756	MASS 24/75, INCL. DNV & LLOYDS CERTIFICATION	kr 19.582,00
40021006	MASS 24/100, INCL. DNV & LLOYDS CERTIFICATION	kr 25.329,00
40040256	MASS 48/25	kr 9.965,00
40040506	MASS 48/50	kr 16.725,00

### • 3 PHASE, 50/60 HZ

Varenr.	Beskrivelse	Vejl. uds. incl. moms
40031006	MASS 24/100-3PH; 3X 400 V	kr 28.219,00
40031010	MASS 24/50-3PH; MAXIMUM INPUT 550V, VOLTAGE AND CURRENT READING ON INTEGRATED DISPLAY GMDSS DIGITAL VOLT/AMPERE METER (FRONT PANEL)	kr 31.477,00
21709150	GMDSS FRONT PANEL FOR MASS 24/25 DNV	kr 4.038,00
21709200	GMDSS FRONT PANEL FOR MASS 24/50	kr 2.913,00
21709300	GMDSS FRONT PANEL FOR MASS 24/75, 24/100 & 24/100-3PH	kr 4.038,00





## Remote monitoring

Varenr.	Beskrivelse			Vejl. uds. incl. moms
	<b>• MASTERBUS</b>			
77010305	MASTerview EASY - 3,5" TOUCH SCREEN TO MONITOR ONE OR MORE MASTERBUS PRODUCTS	kr		3.049,00
77010310	EASyVIEW 5 - TOUCH SCREEN TO MONITOR ONE OR MORE MASTERBUS PRODUCTS	kr		3.394,00
77010050	MASTerview READ-OUT, REMOTE MONITORING	kr		1.288,00
77020100	MASTERSHUNT 500, BATTERY MONITOR, INCL. MAIN FUSE	kr		3.808,00
77020110	MASTERSHUNT 500 - SUITABLE FOR ANL FUSE OR T-FUSE, 12/24/48V	kr		3.049,00
77020200	DC DISTRIBUTION 500, MONITORED FUSE BOX, INCL. 4 ANL FUSES + 1 SPARE	kr		3.348,00
77030100	MASTERBUS USB INTERFACE, FOR QUICK CONFIGURATION ANY MASTERBUS PRODUCT VIA PC	kr		1.645,00
77040600	MASTERBUS CABLE 6 METER	kr		143,00
77041000	MASTERBUS CABLE 10 METER	kr		166,00
77041500	MASTERBUS CABLE 15 METER	kr		178,00
77042500	MASTERBUS CABLE 25 METER	kr		201,00
77045000	MASTERBUS CABLE 100 METER, SPOOL, NO CONNECTORS	kr		889,00
	<b>• MODULAR PANELS</b>			
Varenr.	Beskrivelse			Vejl. uds. incl. moms
70403105	MICC, DIGITAL PANEL	kr		5.844,00
70400050	GMDSS REMOTE PANEL	kr		4.671,00
70403040	C3-RS (ANALOGUE PANEL)	kr		1.496,00
70404100	C4-RB (NOT SUITABLE FOR MASTERBUS COMPATIBLE CHARGERS)	kr		1.102,00
21702000	CHARGER STATUS INTERFACE	kr		939,00
70405030	REMOTE PANEL CC, CHARGE STATUS INDICATOR	kr		1.102,00
41500500	TEMPERATURE SENSOR 6M (INCLUDED WITH ALL CHARGERS)	kr		297,00
41500800	TEMPERATURE SENSOR 15M	kr		415,00
21730300	PC-LINK, GALVANIC ISOLATED, TO CONNECT PC TO CHARGER	kr		1.507,00
	<b>• MODULAR CONNECTION CABLES</b>			
Varenr.	Beskrivelse			Vejl. uds. incl. moms
6502001030	6 METER MODULAR CABLE, 6 WIRE, CROSSED, RJ12 CONNECTORS	kr		113,00
6502100100	10 METER MODULAR CABLE, 6 WIRE, CROSSED, RJ12 CONNECTORS	kr		153,00
6502100150	15 METER MODULAR CABLE, 6 WIRE, CROSSED, RJ12 CONNECTORS	kr		184,00
6502300510	100 METER MODULAR CABLE, 6 WIRE	kr		2.105,00
6408602500	RJ12 CONNECTORS (TELEJACK PLUG), 100 PCS.	kr		545,00
6502300530	STRIPPING & CRIMPING TOOL FOR RJ11/12/45	kr		1.277,00
120108000	COMPLETE SET: 100 MTR MODULAR CABLE, TOOL & RJ12 CONNECTORS	kr		3.704,00



## DC Master series

Varenr.	Beskrivelse	Vejl. uds. incl. moms
81400100	DC MASTER 24/12-3A	kr 424,00
81400200	DC MASTER 24/12-6A	kr 598,00
81400300	DC MASTER 24/12-12A	kr 858,00
81400330	DC MASTER 24/12-24A	kr 2.056,00
81400352	DC MASTER 24/12-50A, IMPROVED TERMINALS, WEIGHT AND LOOKS	kr 5.863,00
81400400	DC MASTER 12/24-3A	kr 1.582,00
81400500	DC MASTER 12/24-7A	kr 1.940,00
81400600	DC MASTER 48/12-6A	kr 1.951,00
81400700	DC MASTER 48/12-9A	kr 1.940,00
81400800	DC MASTER 48/12-20A	kr 3.206,00

Varenr.	Beskrivelse	Vejl. uds. incl. moms
81500600	DC MASTER 12/12-3A	kr 967,00
81500700	DC MASTER 12/12-6A	kr 1.793,00
81500100	DC MASTER 24/12-3A	kr 707,00
81500200	DC MASTER 24/12-6A	kr 1.032,00
81500300	DC MASTER 24/12-12A	kr 1.466,00
81500350	DC MASTER 24/12-24A	kr 3.100,00
0400	DC MASTER 24/24-3A	kr 1.466,00
81500500	DC MASTER 24/24-7A	kr 3.206,00



## Mac & Magic series

Varenr.	Beskrivelse	Vejl. uds. incl. moms
81200100	Mac 24/12-20 – 20 A	kr 2.657,00

Varenr.	Beskrivelse	Vejl. uds. incl. moms
81300300	MAGIC 12/24-10 – 10 A	kr 1.791,00
81300400	MAGIC 12/12-20 – 20 A	kr 1.791,00
81300100	MAGIC 24/12-20 – 20 A	kr 1.791,00
81300200	MAGIC 24/24-20 – 20 A	kr 1.791,00



## Battery Isolators

Varenr.	Beskrivelse	Vejl. uds. incl. moms
83007021	BI 702-S	kr 630,00
83007030	BI 703	kr 988,00
83012021	BI 1202-S	kr 1.171,00
83012031	BI 1203-S	kr 1.592,00

Varenr.	Beskrivelse	Vejl. uds. incl. moms
83116025	BATTERY MATE 1602 IG	kr 1.835,00
83116035	BATTERY MATE 1603 IG	kr 2.056,00
83125035	BATTERY MATE 2503 IG	kr 2.446,00
83301202	CHARGE MATE 1202	kr 641,00
83302502	CHARGE MATE 2502	kr 2.056,00
83304002	CHARGE MATE PRO 40	kr 2.172,00

Varenr.	Beskrivelse	Vejl. uds. incl. moms
83200150	HIGH POWER BATTERY WATCH/DC MAIN SWITCH FOR 12/24 V DC	kr 1.979,00





# Alpha Pro Ladegenerator /Alternators & Regulators

Varenr.	Beskrivelse	Vejl. uds. incl. moms
48512090	12/90, INCL. 3-STEP ALPHA PRO II CHARGE REGULATOR	kr 9.617,00
48512130	12/130, INCL. 3-STEP ALPHA PRO II CHARGE REGULATOR	kr 12.459,00
48512131	12/130 MULTI-BELT, INCL. 3-STEP ALPHA PRO II CHARGE REGULATOR	kr 12.459,00
48524075	24/75, INCL. 3-STEP ALPHA PRO II CHARGE REGULATOR	kr 11.205,00
48524076	24/75 MULTI-BELT, INCL. 3-STEP ALPHA PRO II CHARGE REGULATOR	kr 11.205,00
48524110	24/110, INCL. 3-STEP ALPHA PRO II CHARGE REGULATOR	kr 15.461,00
48524150	24/150, INCL. 3-STEP ALPHA PRO II CHARGE REGULATOR	kr 23.456,00
45512000	ALPHA PRO II (MASTERBUS) 12 & 24V / FOR MASTERVOLT CONNECTION	kr 3.037,00
48512090	12/90, INCL. 3-STEP ALPHA PRO III CHARGE REGULATOR	kr 9.916,00
48512130	12/130, INCL. 3-STEP ALPHA PRO III CHARGE REGULATOR	kr 12.746,00
48512131	12/130 MULTI-BELT, INCL. 3-STEP ALPHA PRO III CHARGE REGULATOR	kr 12.746,00
48524075	24/75, INCL. 3-STEP ALPHA PRO III CHARGE REGULATOR	kr 11.504,00
48524076	24/75 MULTI-BELT, INCL. 3-STEP ALPHA PRO III CHARGE REGULATOR	kr 11.504,00
48524110	24/110, INCL. 3-STEP ALPHA PRO III CHARGE REGULATOR	kr 15.749,00
48524150	24/150, INCL. 3-STEP ALPHA PRO III CHARGE REGULATOR	kr 23.755,00
45512000	ALPHA PRO III (MASTERBUS) 12 & 24V / 20A FIELD CURRENT / FOR MASTERVOLT CONNECTION	kr 3.325,00
41500400	ALTERNATOR TEMPERATURE SENSOR FOR ALPHA PRO III	kr 127,00
48400030	PULLEY MULTI-BELT FOR 24/110 AND 24/150	kr 259,00
45510500	BOSCH ADAPTER FOR ALPHA PRO II / III	kr 148,00

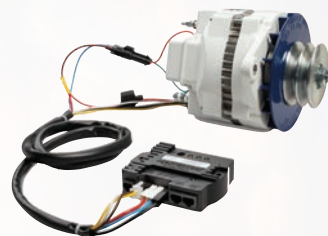

## Automatic Transfer Systems

Varenr.	Beskrivelse	Vejl. uds. incl. moms
<b>• 230 V AC, 50 HZ, WITHOUT PANEL CONNECTION</b>		
55006010	MASTERSWITCH 5 KW – 2X IN, 1X OUT	kr 2.657,00
55006015	MASTERSWITCH 10 KW – 2X IN, 1X OUT	kr 5.200,00
55003500	MASTERSWITCH 25 KW – 2X IN, 1X OUT	kr 11.044,00
55006060	MASTERSWITCH FUSES 5 KW – 2X IN, 2X OUT	kr 7.397,00
<b>• 120 V AC, 60 HZ, WITHOUT PANEL CONNECTION</b>		
Varenr.	Beskrivelse	Vejl. uds. incl. moms
55106000	MASTERSWITCH 3 KW – 2X IN, 1X OUT	kr 4.130,00
55106100	MASTERSWITCH 7 KW – 2X IN, 1X OUT	kr 6.247,00
<b>• 230 V, 50/60 HZ</b>		
Varenr.	Beskrivelse	Vejl. uds. incl. moms
55008005	MASS SYSTEMSWITCH 6	kr 10.043,00
55008105	MASS SYSTEMSWITCH 10	kr 12.010,00
55008205	MASS SYSTEMSWITCH 16	kr 13.494,00



## Mass GI series

Varenr.	Beskrivelse	Vejl. uds. incl. moms
88000355	MASS GI 3.5 – (340 X 261 X 144 MM - 6KG)	kr 10.050,00
88000705	MASS GI 7 – (340X261X250 MM - 10 KG)	kr 18.022,00

## IVET series

Varenr.	Beskrivelse	Vejl. uds. incl. moms
<b>• WITHOUT ENCLOSURE, TAP SELECTABLE</b>		
85000350	IVET 3.5 (330 X 200 X 185 MM – 30 KG)	kr 7.772,00
85000450	IVET 4.5 (330 X 240 X 185 MM – 35 KG)	kr 9.818,00
85000600	IVET 6 (380 X 240 X 215 MM – 50 KG)	kr 13.361,00
85000800	IVET 8 (430 X 280 X 210 MM – 59 KG)	kr 14.626,00
85001000	IVET 10 (430 X 280 X 240 MM – 75 KG)	kr 18.275,00
85001300	IVET 13 (490 X 320 X 230 MM – 90 KG)	kr 23.263,00
85001800	IVET 18 (490 X 320 X 260 MM – 110 KG)	kr 24.939,00
85002200	IVET 22 (490 X 320 X 290 MM – 130 KG)	kr 28.809,00



## Soft Start

Varenr.	Beskrivelse	Vejl. uds. incl. moms
55003300	SOFT START 0-13 KW	kr 2.868,00
55003400	SOFT START 13-22 KW	kr 3.923,00
<b>TRANSFER SYSTEMS WITH SOFT START &amp; AUTOMATIC DETECTION</b>		
Varenr.	Beskrivelse	Vejl. uds. incl. moms
55010600	120/230 V – 6 KW	kr 13.097,00
55010900	120/230 V – 9 KW	kr 16.166,00
55011300	120/230 V – 13 KW	kr 18.159,00

## Analogue meters

Varenr.	Beskrivelse	Vejl. uds. incl. moms
70901110	AC AMPS METER 0-40 A	kr 1.161,00
70901200	AC VOLTMETER 0-300 V	kr 1.161,00

## Battery monitors

Varenr.	Beskrivelse	Vejl. uds. incl. moms
70405060	BattMan Lite, incl. shunt	kr 1.588,00
70405070	BattMan Pro, incl. shunt	kr 1.944,00
70403163	Masterlink/BTM-III, 12/24 V DC, including 500A shunt	kr 3.900,00
70904180	Shunt 1000 A/100 mV (Optional for BTM-III to measure currents up to 1000A)	kr 2.071,00
6801601100	Twisted pairs shielded 3x2x0.25 mm2, for BTM or BattMan Lite / Pro, per meter	kr 62,00
6801601300	Twisted pairs shielded 5x2x0.25 mm2, for BTM, per 100 meter	På forespørgsel



## Shunts & current transformers

Varenr.	Beskrivelse	Vejl. uds. incl. moms
70904100	Shunt 40 A/60 mV	kr 427,00
70904110	SHUNT 60 A/60 MV	kr 498,00
70904130	SHUNT 100 A/60 MV	kr 521,00
70904180	SHUNT 1000 A/100 MV (OPTIONAL FOR BTM-III TO MEASURE CURRENTS UP TO 1000A)	kr 2.071,00
70904190	SHUNT HOLDER 40 A/150 A	kr 427,00



## Wear-proof, UV-proof shore power cable

Varenr.	Beskrivelse	Vejl. uds. incl. moms
121160150	<ul style="list-style-type: none"> <li>• WITH MOULDED PLUGS</li> </ul> 15 METER, 2.5 MM2 – GREEN INCL. CABLE BAG 121160930	kr 1.680,00
121160250	<ul style="list-style-type: none"> <li>• WITH MOULDED PLUGS</li> </ul> 25 METER, 2.5 MM2 – GREEN INCL. CABLE BAG 121160930	kr 2.381,00
121320250	<ul style="list-style-type: none"> <li>• WITH MOULDED PLUGS</li> </ul> 25 METER, 4 MM2	kr 2.795,00



## Wear-proof, UV-proof extension cord

Varenr.	Beskrivelse	Vejl. uds. incl. moms
121160151	<ul style="list-style-type: none"> <li>• WITH MOULDED PLUGS</li> </ul> 15 METER, 2.5 MM2 – GREEN	kr 986,00
121160251	<ul style="list-style-type: none"> <li>• WITH MOULDED PLUGS</li> </ul> 25 METER, 2.5 MM2 – GREEN	kr 1.657,00
121160930	<ul style="list-style-type: none"> <li>• ACCESSORIES</li> </ul> SHORE CABLE BAG	kr 225,00
121160000	<ul style="list-style-type: none"> <li>• RVS SHORE POWER INLET, BUILT-IN</li> </ul> 16 A, 230 V	kr 1.114,00
121320000	<ul style="list-style-type: none"> <li>• RVS SHORE POWER INLET, BUILT-IN</li> </ul> 32 A, 230 V	kr 1.461,00
121160900	<ul style="list-style-type: none"> <li>• ADAPTERS</li> </ul> FROM CEE-7/7 TO CE PLUG	kr 248,00
121160910	<ul style="list-style-type: none"> <li>• ADAPTERS</li> </ul> FROM CE TO CEE-7/7 PLUG	kr 248,00
121160920	<ul style="list-style-type: none"> <li>• ADAPTERS</li> </ul> SPLITTER, FOR CE PLUG	kr 747,00
120500300	<ul style="list-style-type: none"> <li>• COMPLETE SETS (SHORE CABLE EXCLUDED)</li> </ul> SHORE CONNECTION SET VALOX, 16 A	kr 1.737,00
120500400	<ul style="list-style-type: none"> <li>• COMPLETE SETS (SHORE CABLE EXCLUDED)</li> </ul> SHORE CONNECTION SET STAINLESS STEEL, 16 A	kr 2.232,00
120500500	<ul style="list-style-type: none"> <li>• COMPLETE SETS (SHORE CABLE EXCLUDED)</li> </ul> SHORE CONNECTION SET STAINLESS STEEL, 32 A	kr 4.567,00
120500600	<ul style="list-style-type: none"> <li>• COMPLETE SETS (SHORE CABLE EXCLUDED)</li> </ul> SHORE CONNECTION SET, 3-POLE, 32 A	kr 4.832,00
120800400	<ul style="list-style-type: none"> <li>• COMPLETE SETS (SHORE CABLE EXCLUDED)</li> </ul> STAINLESS STEEL 16 A + 25 METER SHORE CABLE	kr 4.924,00
120301000	<ul style="list-style-type: none"> <li>• CABLES (OIL RESISTANT)</li> </ul> YELLOW/ORANGE MOULDED SHORE CABLE, 3X 2.5 MM2, 25 METER	kr 2.439,00
120300100	<ul style="list-style-type: none"> <li>• CABLES (OIL RESISTANT)</li> </ul> YELLOW/ORANGE MOULDED SHORE CABLE, 3X 2.5 MM2, PER METER*	kr 133,00
120301400	<ul style="list-style-type: none"> <li>• CABLES (OIL RESISTANT)</li> </ul> YELLOW/ORANGE MOULDED SHORE CABLE, 3X 4 MM2, PER METER*	kr 170,00
68061100	<ul style="list-style-type: none"> <li>• BATTERY TERMINALS</li> </ul> D, BATTERY TERMINAL WITH M10 THREAD PLUS	kr 23,00
68061200	<ul style="list-style-type: none"> <li>• BATTERY TERMINALS</li> </ul> D, BATTERY TERMINAL WITH M10 THREAD MINUS	kr 23,00
68061300	<ul style="list-style-type: none"> <li>• BATTERY TERMINALS</li> </ul> D, BATTERY TERMINAL WITH M12 THREAD PLUS	kr 35,00
68061400	<ul style="list-style-type: none"> <li>• BATTERY TERMINALS</li> </ul> D, BATTERY TERMINAL WITH M12 THREAD MINUS	kr 35,00
68457302	<ul style="list-style-type: none"> <li>• ISOLATION COVERS</li> </ul> D, COVER 457N3V02 RED, FOR PRODUCTS 68061100/68061300	kr 23,00
68457314	<ul style="list-style-type: none"> <li>• ISOLATION COVERS</li> </ul> D, COVER 457N3V14 BLACK, FOR PRODUCTS 68061200/68061400	kr 23,00



## Sikringer og sikrings holder

<b>• EARTH LEAKAGE SWITCHES</b>		
Varenr.	Beskrivelse	Vejl. uds. incl. moms
6385401610	DPN VIGI 16 A/B/30 MA, 1P+N	kr 1.714,00
124001000	SHORE FIX 16 A/30 MA – IN READY TO USE INSTALLATION BOX	kr 2.312,00
<b>• CONTROL PANELS</b>		
Varenr.	Beskrivelse	Vejl. uds. incl. moms
70403010	BATTERY ALARM 10/30 V, SERIES 3	kr 1.300,00
70403020	BILGE PUMP ALARM 10/30 V, SERIES 3	kr 702,00
75001000	JUNIOR PANEL, 6 CIRCUIT/15 A MAX. PER OUTLET	kr 918,00
<b>• COMBINED FUSE/SWITCH PANEL</b>		

**Vandtætte Afbryder med løse kontakter med symboler**

**Spørg venligst**



# BATTERY DISTRIBUTION

Varenr.	Beskrivelse	Vejl. uds. incl. moms
715-H	CLSTR BAT SW 275A X 3 HORZ	kr 840,00
715-S	CLSTR BAT SW 2X701/1X701S HOZ	kr 1.060,00
715-V	CLSTR BAT SW 275A X 3 VERT	kr 871,00
702	DIST STUD SINGLE 1 X 10MM	kr 237,00
702-2S	DIST STUD DUAL 2 X 10MM	kr 366,00
702-2S/L	DIST STUD DUAL 2 X 10MM & LINK	kr 414,00
702-8	DIST STUD SINGLE 1 X 8MM	kr 249,00
702SB	DIST STUD SECONDARY BUSS	kr 139,00
703-300A	DIST BUSS 300A 4X10MM STUDS	kr 613,00
703-500A	DIST BUSS 500A 3X10MM STUDS	kr 729,00
705-100A	CB HD 100AMP BUSSMAN DSP	kr 1.012,00
705-135A	CB HD 135AMP BUSSMAN DSP	kr 1.012,00
705-50A	CB HD 50AMP BUSSMAN DSP	kr 1.012,00
705-80A	CB HD 80AMP BUSSMAN DSP	kr 1.012,00
706-2W	ESS CIR MOD 24HR 2 X 10A CB	kr 502,00
706-4W	ESS CIR MOD 24HR 4W	kr 1.148,00
708-102	TERM LINKBAR 102MM - 720 VERT.(M12)	kr 197,00
708-107-V3	LINKBAR 107MM CONTOUR CONNECT LINK VERTICAL (M12)	kr 247,00
708-42.5	TERM LINKBAR 42.5MM CENTR 2 CENTR M10 70	kr 42,00
708-54.5	TERM LINKBAR 54.5MM C TO C M10	kr 70,00
708-62.0	TERM LINKBAR 62.0MM - 720 HORIZ (M12)	kr 90,00
708-64.5	TERM LINKBAR 64.5MM C TO C M10	kr 70,00
708-68.5	TERM LINKBAR 68.5MM C TO C	kr 55,00
708-70.0	TERM LINKBAR 70MM CENTRE - CCLINK	kr 58,00
708-88	TERM LINKBAR 88MM CENTRE - 720 & 720MD	kr 106,00
711L	AMMETER SHUNT ENCLOSURE LARGE	kr 689,00
711L-450A	AMMETER ENCLOSURE - SHUNT FITTED 450A	kr 1.168,00



# BATTERY SWITCHES

Varenr.	Beskrivelse	Vejl. uds. incl. moms
701	BAT SW 275A CONT	kr 297,00
701-KEY	BAT SW KEY	kr 63,00
701-KEY-EP	BAT SW KNB YL EP	kr 76,00
701-PM	BAT SW PM 275A CONT	kr 297,00
701S	BAT SW B1B2 200A	kr 513,00
701S-PM	BAT SW PM B1B2 200A CONT	kr 463,00
8010080	BAT SW PM YL KNB	kr 265,00
<b>• EASY FIT</b>		
700	BAT SW EASYFIT 275A CONT	kr 435,00
700-KEY	BAT SW EASYFIT KNOB	kr 64,00
<b>• HEAVY DUTY</b>		
720	BAT SW 600A CONT	kr 855,00
721	BAT SW B1B2 SELECTOR 350A CONT	kr 930,00
<b>• MOTOR DRIVEN</b>		
701-MD	BAT SW MD 275A CONT	kr 1.595,00
701-MDVS	BAT SW MDVS 12V 275A CONT	kr 1.710,00
701-MDVS-24V	BAT SW MDVS 24V 275A CONT	kr 1.527,00
701-MDCZ	BAT SW MD CZONE 275A CONT MC6	kr 1.653,00
720-MDO	BAT SW MD HD 12/24V 500A OPTICS	kr 2.410,00
720-MDO-EP	BAT SW MD HD 12/24V 500A OPTICS E/P	kr 2.162,00
720-MDVSO	BAT SW MDVS HD 12V 500A OPTIC CONT	kr 2.090,00
80-701-0018-00	BAT SW MD EP 275A CONT	kr 1.424,00
80-708-0013-00	LINK BAR KIT 720MDO	kr 400,00
80-708-0017-00	LINK BAR KIT 701MD	kr 410,00
80-724-0006-00	KEY SW CNTRL FOR MD	kr 915,00
80-724-0007-00	SW CNTRL FOR MDVS	kr 406,00
<b>• MOUNTING PLATES</b>		
BSP-1	MOUNTING PLATE FOR 701 SINGLE RECESSED	kr 320,00
BSP-3	TRIPLE RECESSED MOUNTING PLATE FOR 701	kr 480,00



# BATTERY SWITCHES - MOUNTING PLATES

**• PRO INSTALLER RETAIL PACKAGING**

Varenr.	Beskrivelse		Vejl. uds. incl. moms
770	400A SINGLE POLE ON/OFF BATT SW -STD MOUNT	kr	528,00
770-EZ	400A SINGLE POLE ON/OFF BATT SW -EZ MOUNT	kr	548,00
770-DP	400A DOUBLE POLE ON/OFF BATT SW -STD MOUNT	kr	632,00
770-DP-EZ	BAT SW PI 400A EZ MOUNT DP MC10	kr	700,00
770-KEY-EP	BAT SW KNB 770 YL EP MC10	kr	106,00
SET-770	LBL SET FOR 770 BAT SW	kr	148,00
771-S	400A SELECTOR BATT SW -STD MOUNT	kr	624,00
771-S-EZ	400A SELECTOR BATT SW -EZ MOUNT	kr	590,00
771-SFD	400A SELECTOR BATT SW WITH AFD -STD MOUNT	kr	547,00
772-DBC	400A DUAL BANK CONTROL SWITCH -STD MOUNT	kr	709,00
772-DBC-EZ	BAT SW PI 400A EZ MOUNT DUAL BANK CONTROL MC10	kr	710,00
777-BB8S-650	8 STUD HEAVY DUTY BUSBAR & COVER -650 AMP	kr	1.260,00
777-BB5S-650	5 STUD HEAVY DUTY BUSBAR & COVER -650 AMP	kr	910,00
777-BB3S-650	3 STUD HEAVY DUTY BUSBAR & COVER -650 AMP	kr	677,00
777-BB4S-500	4 STUD HEAVY DUTY BUSBAR & COVER -500 AMP	kr	617,00
777-Z18W-200	Z BAR 18 WAY BUSBAR & COVER -2X200 AMP	kr	306,00
777-Z10W-200	Z BAR 10 WAY BUSBAR & COVER -2X200 AMP	kr	246,00
778-ANL	ANL FUSEHOLDER -300A	kr	215,00
778-ANLTP	ANL THROUGH-PANEL FUSEHOLDER -500A	kr	521,00
778-ANL2S	ANL FUSEHOLDER WITH ADDITIONAL STUDS -750A	kr	437,00
778-T2S-400	CLASS T FUSEHOLDER WITH ADDITIONAL STUDS -225-400A	kr	437,00
778-T2S-600	CLASS T FUSEHOLDER WITH ADDITIONAL STUDS -450-600A	kr	512,00
IST-8MM-1S	SINGLE 8MM STUD	kr	109,00
IST-8MM-1SPT	SINGLE 8MM STUD WITH POWER TAP PLATE	kr	184,00
IST-8MM-2S	8MM DOUBLE INSULATED STUD	kr	175,00
IST-10MM-8MM	DOUBLE INSULATED STUD WITH 1 X 10MM, AND 1X 8MM STUDS	kr	178,00
IST-10MM-1S	SINGLE 10MM STUD	kr	110,00
IST-10MM-1SPT	SINGLE 10MM STUD WITH POWER TAP PLATE	kr	190,00
IST-10MM-2S	10MM DOUBLE INSULATED STUD	kr	182,00
MRBF	TERMINAL FUSE BLOCK 30-300AMP + COVER	kr	279,00
MRBF-50A	TERMINAL FUSE 50AMP	kr	157,00
MRBF-80A	TERMINAL FUSE 80AMP	kr	157,00
MRBF-100A	TERMINAL FUSE 100AMP	kr	157,00
MRBF-125A	TERMINAL FUSE 125AMP	kr	157,00
MRBF-150A	TERMINAL FUSE 150AMP	kr	157,00
MRBF-200A	TERMINAL FUSE 200AMP	kr	157,00
MRBF-300A	TERMINAL FUSE 300AMP	kr	157,00
MRCBF-200A	HD CB BUSSMAN 187 SERIES 200A FLUSH MOUNT	kr	1.003,00
MRCBP-200A	HD CB BUSSMAN 187 SERIES 200A PANEL MOUNT	kr	1.003,00
FT-225-B	FUSE CLASS T 225A	kr	697,00
FT-250-B	FUSE CLASS T 250A	kr	697,00
FT-300-B	FUSE CLASS T 300A	kr	697,00
FT-350-B	FUSE CLASS T 350A	kr	697,00
FT-400-B	FUSE CLASS T 400A	kr	697,00
FT-450-B	FUSE CLASS T 450A	kr	697,00
FT-500-B	FUSE CLASS T 500A	kr	697,00
FT-600-B	FUSE CLASS T 600A	kr	697,00





## BUS BARS, INSULATED STUDS & COVERS

DSP = Blisterpakning kan også leveres uden Blister, spørg venligst på pris.

Varenr.	Beskrivelse	Vejl. uds. incl. moms
BB-12W-2NC/DSP	BUS BAR 12W X 2 DSP	kr 222,00
BB-12W-2S/DSP	BUS BAR 12W 2 INPUT STUDS DSP	kr 176,00
BB-24W-2S/DSP	BUS BAR 1X24WAY + COVERS DSP	kr 258,00
BB-4S-150A/DSP	BUS BAR 4X6MM 1/4 STUDS 150A DSP	kr 395,00
BB-6W-2	BUS BAR MULTI 6WX2 AC/DC	kr 694,00
BB-6W-2NC/DSP	BUS BAR 2X6WAY DBLE STUD + COVERS	kr 273,00
BB-6W-2S/DSP	BUS BAR 1X6WAY + COVERS DSP	kr 153,00
BBC-12WBK	BUS BAR COVER (BLACK) NEGATIVE 12W	kr 45,00
BBC-12WR	BUS BAR COVER (RED) POSITIVE 12W	kr 45,00
BBC-24WBK	BUS BAR COVER (BLACK) NEGATIVE 24W	kr 51,00
BBC-6WBK	BUS BAR COVER (BLACK) NEG 6W	kr 36,00
BBC-6WR	BUS BAR COVER (RED) POS 6W	kr 36,00
IS-10MM-1	INSULATED STUDS 10MM X 1 NEG	kr 70,00
IS-10MM-1R	INSULATED STUDS 10MM X 1 POS	kr 70,00
IS-10MM-2	INSULATED STUDS 10MM X 2	kr 104,00
IS-10MM-2/L	INSULATED STUDS 10MM X 2 & LINK6	kr 162,00
IS-10MM-8MM	INSULATED STUDS 10MM X 1 8MM X 1	kr 121,00
IS-6MM-1/DSP	INSULATED STUDS 6MM X 1 NEG DSP	kr 85,00
IS-6MM-1R/DSP	INSULATED STUDS 6MM X 1 POS DSP	kr 85,00
IS-6MM-2/DSP	INSULATED STUDS 6MM X 2 DSP	kr 101,00
IS-8MM-1	INSULATED STUDS 8MM X 1 NEG	kr 69,00
IS-8MM-1R	INSULATED STUDS 8MM X 1 POS	kr 69,00
<b>• BUS BARS, INSULATED STUDS &amp; COVERS</b>		
ISC-10BK	INSULATED STUD COVER (BLK) NEG	kr 27,00
ISC-10BK-S	INSULATED STUD COVER (BLK) 8MM SLEEVE	kr 1,00
ISC-10R	INSULATED STUD COVER (RED) POS	kr 29,00
ISC-6-2	INSULATED STUD COVER DUAL (BLK) NEG	kr 27,00
TB-118-10P	TERMINAL STRIP 30A 10W	kr 73,00
TB-118-6P	TERMINAL STRIP 30A 6W	kr 49,00
TB-118-6P/DSP	TERMINAL STRIP 30A 6W DSP	kr 89,00



## CIRCUIT BREAKERS - HEAVY DUTY

Varenr.	Beskrivelse	Vejl. uds. incl. moms
CBL-100A-DP	CB LRG 100A DP	kr 871,00
CBL-100A-SP-IGN	CB LRG 100A SP IGN. PROTECTION	kr 584,00
CBL-50A-SP	CB LRG 50A SP	kr 584,00
CBL-60A-DP	CB LRG 60A DP	kr 953,00
CBL-60A-SP	CB LRG 60A SP	kr 584,00
CBL-75A-SP	CB LRG 75AMP SP	kr 584,00
CBL-80A-DP	CB LRG 80AMP DP	kr 871,00
CBL-80A-TP	CB LRG 80AMP TP	kr 1.127,00



# CIRCUIT BREAKERS - PUSH TO RESET

Varenr.	Beskrivelse	Vejl. uds. incl. moms
184050P-01-1	HD CB 50A MAN RESET PAN MNT	kr 512,00
184060P-01-1	HD CB 60A MAN RESET PAN MNT	kr 512,00
184100F-01-1	HD CB 100A MAN RESET SURFACE MNT	kr 512,00
184100P-01-1	HD CB 100A MAN RESET PAN MNT	kr 512,00
184150F-01-1	HD CB 150A MAN RESET SURFACE MNT	kr 512,00
184150P-01-1	HD CB 150A MAN RESET PAN MNT	kr 512,00
184COVER	COVER SURFACE MOUNT FOR 184 HD CB	kr 54,00
185030F/DSP	HD CB 30A SW RESET SURFACE MNT DSP	kr 597,00
185040F/DSP	HD CB 40A SW RESET SURFACE MNT DSP	kr 597,00
185040P/DSP	HD CB 40A SW RESET PAN/MNT DSP	kr 597,00
185050F/DSP	HD CB 50A SW RESET SURFACE MNT DSP	kr 597,00
185050P/DSP	HD CB 50A SW RESET PAN MNT DSP	kr 597,00
185060P/DSP	HD CB 60A SW RESET PAN MNT DSP	kr 597,00
185070P/DSP	HD CB 70A SW RESET PAN MNT DSP	kr 597,00
185080F/DSP	HD CB 80A SW RESET SURFACE MNT DSP	kr 597,00
185080P/DSP	HD CB 80A SW RESET PAN MNT DSP	kr 597,00
185100F/DSP	HD CB 100A SW RESET SURFACE MNT DSP	kr 597,00
185100P/DSP	HD CB 100A SW RESET PAN MNT D/PACK	kr 597,00
185120P/DSP	HD CB 120A SW RESET PAN/MNT DSP	kr 597,00
185135P/DSP	HD CB 135A SW RESET PAN MNT DSP	kr 597,00
185150F/DSP	HD CB 150A SW RESET SURFACE MNT DSP	kr 597,00
185150P/DSP	HD CB 150A SW RESET PAN MNT DSP	kr 597,00



## CARLING

Varenr.	Beskrivelse	Vejl. uds. incl. moms
CLB-05	CB CARLING THERMAL PUSH RESET 5A	kr 51,00
CLB-07	CB CARLING THERMAL PUSH RESET 7A	kr 51,00
CLB-10	CB CARLING THERMAL PUSH RESET 10A	kr 51,00
CLB-15	CB CARLING THERMAL PUSH RESET 15A	kr 51,00
CLB-20	CB CARLING THERMAL PUSH RESET 20A	kr 51,00
CLB-25	CB CARLING THERMAL PUSH RESET 25A	kr 51,00
CLB-30	CB CARLING THERMAL PUSH RESET 30A	kr 51,00
CLB-40	CB CARLING THERMAL PUSH RESET 40A	kr 51,00
CLB-BOOT	CLB BOOT FULL PUSHBUTTON	kr 25,00
PMCC-10	CONT CONNECT PTR SPACER RESET CAP	kr 8,25

## STANDARD

Varenr.	Beskrivelse	Vejl. uds. incl. moms
CBS-10A-DP	CB SML 10AMP DP	kr 482,00
CBS-10A-SP	CB SML 10AMP SP	kr 204,00
CBS-10A-SP-IGP	CB SML 10A SP IGN.PROTECTION	kr 204,00
CBS-12.5A-SP	CB SML 12.5A SP	kr 204,00
CBS-15A-DP	CB SML 15AMP DP	kr 482,00
CBS-15A-DP-TC230	CB SML 15A DP 230VAC TRIPCOIL	kr 799,00
CBS-15A-SP	CB SML 15AMP SP	kr 204,00
CBS-2.5A-SP	CB SML 2.5AMP SP	kr 204,00
CBS-20A-DP	CB SML 20AMP DP	kr 482,00
CBS-20A-SP	CB SML 20AMP SP	kr 204,00
CBS-25A-SP	CB SML 25AMP SP	kr 204,00
CBS-30A-DP-TC230	CB SML 30A DP 230VAC TRIPCOIL	kr 799,00
CBS-30A-SP	CB SML 30AMP SP	kr 204,00
CBS-30A-TP	CB SML 30AMP TP	kr 687,00
CBS-40A-SP	CB SML 40AMP SP	kr 204,00
CBS-50A-SP-IGP	CB SML 50A SP IGN. PROTECTION	kr 204,00
CBS-5A-DP	CB SML 5AMP DP	kr 482,00
CBS-5A-SP	CB SML 5AMP SP	kr 204,00





# CONTOUR CONNECT - AFTER MARKET

Varenr.	Beskrivelse	Vejl. uds. incl. moms
709-250/DD	FLEX TERM LINK 25 X250 - 2X22-10	kr 137,00
CC-1	CC 2 HOLE MODULE BODY - CHAR	kr 324,00
CC-2	CC 1 HOLE 4 CB MODULE BODY - CHAR	kr 472,00
CC-5	CC 3 HOLE MODULE BODY - CHAR	kr 430,00
CC-801	CC SINGLE ENG. BATT.SELECTOR VSR MODULE	kr 1.723,00
CC-802	CC SINGLE ENG. BATT.SW. VSR COMBO	kr 3.007,00
CC-803N	CC TWIN ENG. BAT SW. VSR COMBO 2X3 MOD	kr 4.244,00
CC-804	CC H/DUTY CB - 4 CB MODULE	kr 2.371,00
CC-810	CC S/ ENG. 3 X BATTERY SW COMBO	kr 1.781,00
CC-BLANK	CC SINGLE CIRCULAR MODULE BLANK	kr 281,00
CC-HDBM	CC MOUNTING HARDWARE FOR CB BUSMAN	kr 109,00
CC-WS/CH	CC 2WAY WAVE STRIP SET CHARCOAL	kr 70,00
LD-6R-120-CE	CBL 6 RED X 120 - QKC40/QKC42	kr 25,00
LD-6R-150-BD	CBL 6 RED X 150 - 1XQKC39/ 1XQKC41	kr 16,00
NCB-CC	BAR COPPER 4W SLOTTED FOR CC	kr 22,00
	<b>• MTR DRIVEN</b>	kr
80-700-0050-00	CC KEY SW & 4 X CB MOD SGL ENG	kr 3.146,00
80-700-0051-00	CC KEY SW & 4 X CB MOD TWIN ENG	kr 3.789,00
80-700-0052-00	CC KEY SW & 4 X CB MOD TRPL ENG	kr 3.134,00

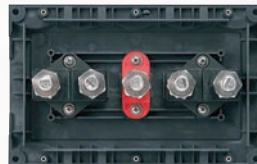

# ELECTRICAL ACCESSORIES

Varenr.	Beskrivelse	Vejl. uds. incl. moms
12VRC/DSP	RECEPTACLE DELUXE 12V DSP	kr 109,00
12VBR/BP-DSP	SOCKET & PLUG 50A + BACKPLATE MP24	kr 474,00
12VPG/DSP	PLUG DELUXE 12V DSP MP24	kr 129,00
121-710-1101/1	CB TOGGLE LOCK BLACK	kr 24,00
54-27C4	BUZZER PIEZO 30MM 5-30VS 85DB	kr 75,00
54-27C4/DSP	BUZZER PIEZO 30MM 5-30VS 85DB DISP PACK	kr 94,00
54-35C2	BUZZER PIEZO 42MM 5-20 VS 97DB	kr 120,00
54-35C2/DSP	BUZZER PIEZO 42MM 5-20V 97DB DSP	kr 136,00
80-511-0001-00	PUSH BUT SW ON/OFF RING ILLUM 12V RED LED DSP	kr 307,00
80-511-0002-00	PUSH BUT SW MOM RING ILLUM 12V RED LED DSP	kr 307,00
80-511-0003-00	PUSH BUT SW ON/OFF RING ILLUM 12V BLU LED DSP	kr 307,00
80-511-0004-00	PUSH BUT SW MOM RING ILLUM 12V BLU LED DSP	kr 307,00
80-511-0005-00	PUSH BUT SW ON/OFF RING ILLUM 24V RED LED DSP	kr 307,00
80-511-0006-00	PUSH BUT SW MOM RING ILLUM 24V RED LED DSP	kr 307,00
80-511-0007-00	PUSH BUT SW ON/OFF RING ILLUM 24V BLU LED DSP	kr 307,00
80-511-0008-00	PUSH BUT SW MOM RING ILLUM 24V BLU LED DSP	kr 307,00
80-511-0009-00	BUZZER & WARN LGT METAL DC12V DSP	kr 322,00
80-511-0010-00	BUZZER & WARN LGT METAL DC24V DSP	kr 322,00
MCB-3WENC	ENCL MINI CB 3W C/W AUST NEG BAR	kr 1.045,00
N0100A	AMMETER DC 0-100A 50MV CONTOUR SERIES	kr 410,00
N0100ACT	AMMETER AC 0-100A CONTOUR SERIES	kr 410,00
N010A	AMMETER DC 0-10A CONTR SERIES INT/SHUNT	kr 471,00
N0150A	AMMETER DC 0-150A 50MV	kr 410,00
N0150ACV	VMETER AC 0-150V CONTOUR SERIES	kr 410,00
N020A	AMMETER DC 0-20A CONTR SERIES INT/SHUNT	kr 471,00
N0300ACV	VMETER AC 0-300V CONTOUR SERIES	kr 410,00
N050A	AMMETER DC 0-50A 50MV CONTOUR SERIES	kr 369,00
N060ACT	AMMETER AC 0-60A CONTOUR SERIES	kr 410,00
PCB-4W-AC230-SP	PCB ASSY 4 WAY AC230	kr 258,00
SW-32111	SW TOG 10A ON/OFF C/W N&P	kr 39,00
SW-32113	SW TOG 20A ON/ON C/W N&P	kr 39,00
SW-32114	SW TOG 10A SPDT ON/OFF/ON C/W N&P	kr 42,00
SW-32115	SW TOG 10A (ON)OFF C/W N&P	kr 49,00
SW-32120	SW TOG 10A SP (ON)OFF(ON) C/W N&P	kr 40,00
SW-32122	SW TOG 10A DP (ON)OFF(ON) C/W N&P	kr 78,00
SW-32123	SW TOG 10A DPDT ON/OFF/ON C/W N&P	kr 52,00
SW-32124	SW TOG 10A DP ON/OFF C/W N&P	kr 46,00
SW-6064B3P	SW CONTOUR SW ON/ON	kr 28,00
SW-6064C3P	SW CONTOUR SW ON/OFF/ON	kr 34,00
SW-6064D3P	SW CONTOUR SW ON/OFF/ (ON)	kr 37,00
SW-CG1	SW ROCKER ON-OFF FOR CG2	kr 23,00
SW-CG2	SW ROCKER (ON)-OFF FOR CG2	kr 47,00
SW-CG3	SW ROCKER ON-OFF-ON FOR CG2	kr 24,00
SW-CG4	SW ROCKER (ON)-OFF-(ON) FOR CG2	kr 24,00
SW-CG5	SW ROCKER ON-ON FOR CG2	kr 24,00
SW-M331	SW TOGGLE COVER & WASHER	kr 15,00
SW-RVS2	SW ROCKER ON-OFF LED 13A RV PAN	kr 54,00
<b>• FUSE HOLDERS &amp; FUSES</b>		
2ATC-6W	RV FH ATC 6W SCREW TERM & COVER	kr 237,00
702-MFH	MAXI FUSE HOLDER	kr 181,00
702-MFH-B	MAXI FUSE HOLDER BULK MP10	kr 137,00

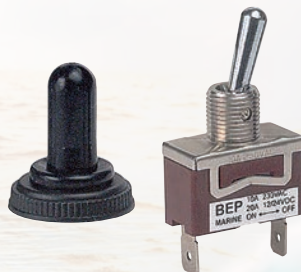



## • FUSE HOLDERS & FUSES

Varenr.	Beskrivelse	Vejl. uds. incl. moms
704-ANL	FH ANL HD SIKRINGSHOLDER I HUS	kr 518,00
80-712-0039-00	NEG BUS FOR ATC 6W	kr 162,00
80-712-0039-01	NEG BUS FOR ATC 6W BULK MP24	kr 94,00
ATC-6W	FH 6W SCRWB TERM C/W CVR & LNK	kr 237,00
ATC-6WQC	FH 6W QUICK CON C/W COVER & LINK	kr 270,00
BB-LINK17MM	BUS BAR LINK FOR 12WAY. 17MM CENTRES	kr 14,00
BB-LINK26MM	BUS BAR LINK 26MM FOR IS 6MM STUD	kr 30,00
BFHD-30A/DSP	AUTO SIKRING HD 30 AMP DSP	kr 51,00
BFHD-40A/DSP	AUTO SIKRING HD 40 AMP DSP	kr 51,00
BFHD-50A/DSP	AUTO SIKRING HD 50 AMP DSP	kr 57,00
BFHD-60A/DSP	AUTO SIKRING HD 60 AMP DSP	kr 51,00
BFHD-70A/DSP	AUTO SIKRING HD 70 AMP DSP	kr 51,00
BFHD-80A/DSP	AUTO SIKRING HD 80 AMP DSP	kr 51,00
HDBFH	FH BLADE HD (WIRES 8AWG X 12")	kr 83,00
HDBFH/DSP	FH BLADE HD DSP	kr 197,00
IP50P/DSP	SIKRING ANL 50A IGNITION PROTECTED DSP	kr 136,00
IP63P/DSP	SIKRING ANL 63A IGNITION PROTECTED DSP	kr 136,00
IP80P/DSP	SIKRING ANL 80A IGNITION PROTECTED DSP	kr 136,00
IP100P/DSP	SIKRING ANL 100A IGNITION PROTECTED DSP	kr 136,00
IP150P/DSP	SIKRING ANL 150A IGNITION PROTECTED DSP	kr 136,00
IP200P/DSP	SIKRING ANL 200A IGNITION PROTECTED DSP	kr 136,00
IP250P/DSP	SIKRING ANL 250A IGNITION PROTECTED DSP	kr 136,00
IP300P/DSP	SIKRING ANL 300A IGNITION PROTECTED DSP	kr 136,00
IP425P/DSP	SIKRING ANL 425A IGNITION PROTECTED DSP	kr 136,00
IP500P/DSP	SIKRING ANL 500A IGNITION PROTECTED DSP	kr 136,00

## ANL SIKRINGER KAN LEVERES UDEN BLISTER PAKNING DSP SPØRG VENLIGST

J01A	SIKRING 1A JAP AUTO STANDART	kr 10,00
J02A	SIKRING 2A JAP AUTO STANDART	kr 10,00
J03A	SIKRING 3A JAP AUTO STANDART	kr 5,00
J05A	SIKRING 5A JAP AUTO STANDART	kr 5,00
J7.5A	SIKRING 7.5A JAP AUTO STANDART	kr 10,00
J10A	SIKRING 10A JAP AUTO STANDART	kr 5,00
J15A	SIKRING 15A JAP AUTO STANDART	kr 5,00
J20A	SIKRING 20A JAP AUTO STANDART	kr 5,00
J25A	SIKRING 25A JAP AUTO STANDART	kr 5,00
J30A	SIKRING 30A JAP AUTO STANDART	kr 5,00
J40A	SIKRING 40A JAP AUTO STANDART	kr 10,00
WAFH-14	SIKRINGSHOLDER VDT. MED LEDNING 2X100 MM	kr 47,00

## • GAS DETECTION

600-GD	CONTOUR MATRIX GAS DETECTOR	kr 2.674,00
600-GDL	CONTOUR MATRIX GAS DETECTOR & CTL	kr 2.613,00
600-GDRV	CONTOUR MATRIX FUME DETECTOR	kr 1.763,00
600-LPG	PAN LPG SHUTOFF CONTROL	kr 898,00
BL-SL-L	SENSOR LEAD GAS/LPG 5 MTR DSP	kr 932,00
FD-2	CONTOUR MATRIX FUME DETEC C/W 5M LD	kr 2.383,00
SA296COMP-12V	12V LPG SOLENOID SHUT OFF NI PLATED	kr 1.445,00
SA296COMP-24V	24V LPG SOLENOID SHUT OFF NI PLATED	kr 1.445,00
VR2.2	LPG REGULATOR & 12V SOLENOID W/ C/M REG	kr 1.939,00
VR2-24V	LPG REG. & 24V #NOT FOR USE WITH 600-GDL#	kr 2.115,00

## • LABELS

713	LABEL SET BAT SW	kr 205,00
713-BT	LBL OVAL BAT SW BOW THRUSTER	kr 17,00
713-EP	LBL OVAL BAT SW EMERG PAR	kr 17,00
713-GEN	LBL OVAL BAT SW GENSET	kr 17,00
713-HB	LBL OVAL BAT SW HOUSE BAT	kr 17,00
713-INV	LBL OVAL BAT SW INVERTER	kr 17,00
713-MS	LBL OVAL BAT SW MID START	kr 17,00
713-PS	LBL OVAL BAT SW PORT START	kr 17,00
713-SB	LBL OVAL BAT SW START BATTERY	kr 17,00
713-SS	LBL OVAL BAT SW STARBOARD START	kr 17,00
713-ST	LBL OVAL BAT SW STERN THRUSTER	kr 17,00
LBL-MIC1	LBL PACK MICRO SET 1 - POWER BOAT	kr 64,00
LBL-MIC2	LBL PACK MICRO SET 2 - DASH	kr 64,00
LBL-MICSYMB	LBL PACK MICRO SYMBOLS	kr 89,00
LBL-RESIN	LBL SPEC RESIN FOR BATT SW-EXPRESS SIGNS	kr 140,00
LBL-WP	LBL WATERPROOF PAN SET	kr 16,00



## 12 VOLT - START

TYPE	TEKNOLOGI	DIN	PRIS INCL MOMS	KAPACITET			KASSE	STØRSTE UDVENDIGE MÅL I MM			VÆGT (KG)	POL-STILLING	POL-TYPE
				MCA	20H Ah	CCA		L	B	H			
EM900	AGM Orbital	-	1.480	900	42	700	G86	235	175	206	15,84	9	1/BOLT
EM1000	AGM Orbital	-	1.800	1000	50	800	G34	265	175	206	17,93	9	1/BOLT
EM1100	AGM Flat	-	3.000	1100	100	925	G31	330	175	240	33,20	9	1/BOLT
EN500	Standard	-	670	500	50	450	L01	210	175	190	13,00	0	1
EN600	Standard	-	710	600	62	540	L02	245	175	190	15,09	0	1
EN750	Standard	-	860	750	74	680	L03	280	175	190	17,68	0	1
EN850	Standard	-	1.380	850	110	750	D02	350	175	235	27,48	1	1
EN900	Standard	-	1.830	900	140	800	D04	515	190	225	36,67	3	1
EN1100	Standard	-	2.030	1100	180	1000	D05	515	225	225	44,62	3	1

## 12 VOLT - DUAL

TYPE	TEKNOLOGI	DIN	PRIS INCL MOMS	KAPACITET			KASSE	STØRSTE UDVENDIGE MÅL I MM			VÆGT (KG)	POL-STILLING	POL-TYPE
				Wh	20H Ah	CCA		L	B	H			
EP450	AGM Orbital	90001	1.800	450	50	750	G34	265	175	206	18,64	9	1/BOLT
EP500	AGM Flat	-	1.350	500	60	680	L02	242	175	190	17,90	0	1
EP600	AGM Flat	-	1.480	600	70	760	L03	278	175	190	20,90	0	1
EP650	AGM Flat	-	2.200	650	75	770	D26	270	175	225	22,70	1	1
EP800	AGM Flat	-	1.780	800	95	850	L05	353	175	190	26,50	0	1
EP900	AGM Flat	-	2.800	900	100	720	G31	330	175	240	31,84	9	1/BOLT
EP1200	AGM Flat	-	2.900	1200	140	700	D04	515	190	225	44,34	3	1
EP1500	AGM Flat	-	3.800	1500	180	900	D05	515	225	225	54,23	3	1
EP2100	AGM Flat	-	4.800	2100	240	1200	D06	520	280	240	72,00	3	1
ER350	Standard	58003	920	350	40	510	D26	270	175	225	18,83	1	1
ER450	Standard	-	1.290	450	95	650	D31	310	175	225	23,26	1	1
ER550	Standard	61500	1.510	550	115	760	D02	350	175	235	28,56	1	1
ER650	Standard	-	1.830	650	142	850	D03	350	175	290	35,00	1	1

## 6 / 12 VOLT - EQUIPMENT

TYPE	TEKNOLOGI	DIN	PRIS INCL MOMS	KAPACITET			KASSE	STØRSTE UDVENDIGE MÅL I MM			VÆGT (KG)	POL-STILLING	POL-TYPE
				Wh	20H Ah	CCA		L	B	H			
ES290	GEL	G25	970	290	25	240	P24	165	175	125	9,60	0	FLAD
ES450	GEL	G40	1.300	450	40	280	LB1	210	175	175	15,00	0	19
ES650	GEL	G60	1.600	650	56	460	L03	278	175	190	20,80	0	1
ES900	GEL	G80	1.900	900	80	540	L05	353	175	190	26,80	0	1
ES950	GEL	G85	2.100	950	85	460	D02	330	171	235	30,00	1	1
ES1000-6	GEL 6V	-	2.100	1000	195	-	GC2	245	190	275	29,00	0	1
ES1100-6	GEL 6V	-	2.500	1100	200	-	GC2	245	190	275	32,00	0	SKRUE
ES1200	GEL	G110	3.100	1200	110	760	D07	286	270	230	38,70	2	1
ES1300	GEL	G120S	2.900	1300	120	750	D03	350	175	290	38,70	0	1
ES1350	GEL	G120	3.000	1350	120	760	D04	515	190	225	40,00	3	1
ES1600	GEL	G140	3.600	1600	140	900	D05	515	225	225	47,00	3	1
ES2400	GEL	G210	4.700	2400	210	1030	D06	520	280	240	67,00	3	1
ET650	Semitraktion	95803	1.400	650	100	800	L05	353	175	190	26,50	0	1
ET950	Semitraktion	96051	2.050	950	135	700	D04	513	190	223	39,45	3	1
ET1300	Semitraktion	96351	2.400	1300	180	900	D05	513	223	223	49,74	3	1
ET1600	Semitraktion	96801	2.950	1600	230	1100	D06	520	280	240	64,84	3	1





Watermaker AQUA-BASE

Varenr.	Beskrivelse	Vejl. uds. incl. moms					
			1	2	3	4	5
ESB 30	35 L/H - 12VDC/24VDC	39.667	S	N	N	N	O
ESB 60	65 L/H - 12VDC/24VDC	44.455	S	N	N	N	O
ESW 30	35 L/H - 12VDC/24VDC	44.797	S	S	O	O	O
ESW 60	65 L/H - 12VDC/24VDC	51.978	S	S	O	O	O
ESW 90	105 L/H - 12VDC/24VDC	58.817	S	S	O	O	O
821237	OPTION CDE DISTANCE ESW / ESW Remote Control	1.983					
752054	LOT DE MAINTENANCE ESB/ESW Maintenance Set	684	S	STANDART			
825953	BITENSION 35L - 12VDC/230VAC - 35L Dual Power	4.069	O	OPTION			
825955	BITENSION 35L - 24VDC/230VAC - 35L Dual Power	4.069	N	NON			
825954	BITENSION 65/105L - 12VDC/230VAC - 65/105L Dual Power	8.173					
825956	BITENSION 65/105L - 24VDC/230VAC - 65/105L Dual Power	8.173					
111123-82	RINCAGE AUTOMATIQUE - ESW - AUTO FLUSH	5.300					
XD121	30 L/H - 12VCC/12VDC	43.087	S	S	O	O	N
XD122	60 L/H - 12VCC/12VDC	50.268	S	S	O	O	N
XD241	30 L/H - 24VCC/24VDC	43.087	S	S	O	O	N
XD242	60 L/H - 24VCC/24VDC	50.268	S	S	O	O	N
XA221	30 L/H - 230VAC-115VAC	43.087	S	S	O	O	N
XA222	60 L/H - 230VAC-115VAC	50.268	S	S	O	O	N
XA223	90 L/H - 230VAC-115VAC	57.107	S	S	O	O	N
YC1	60 L/H - 230/1/50-400/3/50-115/1/60-230/3/60	54.714	S	S	O	O	N
YC2	120 L/H - 230/1/50-400/3/50-115/1/60-230/3/60	66.340	S	S	O	O	N
YC3	180 L/H - 230/1/50-400/3/50-115/1/60-230/3/60	74.889	S	S	O	O	N
YC4	240 L/H - 230/1/50-400/3/50-115/1/60-230/3/60	84.464	S	S	O	O	N
YC5	300 L/H - Tri Phase 400/3/50-440/3/60	93.697	S	S	O	O	N
YC5	300 L/H - Mono/Single Phase 230/1/50	95.749	S	S	O	O	N
YK1	60 L/H - 230/1/50-400/3/50-115/1/60-230/3/60	55.398	S	S	O	O	N
YK2	120 L/H - 230/1/50-400/3/50-115/1/60-230/3/60	67.024	S	S	O	O	N
YK3	180 L/H - 230/1/50-400/3/50-115/1/60-230/3/60	75.573	S	S	O	O	N
YK4	240 L/H - 230/1/50-400/3/50-115/1/60-230/3/60	85.184	S	S	O	O	N
YK5	300 L/H - Tri Phase 400/3/50-440/3/60	94.381	S	S	O	O	N
YK5	300 L/H - Mono/Single Phase 230/1/50	96.433	S	S	O	O	N
102121-10	OPTION SEPARATION MEMBRANES MODELES X X SERIES MEMBRANES SEPARATION OPTION	957					
821215	KIT SEPARATION MEMBRANES MODELES X X SERIES MEMBRANES SEPARATION KIT	1.368					
821216	OPTION SEPARATION MEMBRANES YC1/YC2/YC3 YC1/YC2/YC3 MEMBRANES SEPARATION OPTION	957					
821217	OPTION SEPARATION MEMBRANES YC4/YC5 YC4/YC5 MEMBRANES SEPARATION OPTION	957					
821237	COMMANDE A DISTANCE avec câble 10m REMOTE CONTROL PANEL with 10m cable	1.983					
821239	COMMANDE A DISTANCE avec câble 15,40m et connecteur REMOTE CONTROL PANEL with 15,40m cable and connector	2.975					
102221-82	AUTO-FLUSHING MODELES X ET Y X AND Y SERIES AUTO-FLUSH	5.164					
812013	FILTRE A SABLE SERIE Y - COMPACT 250 Y SERIES - 250 COMPACT SAND FILTER	6.292					
812008	FILTRE A SABLE SERIE Y - PROFESSIONNEL 450 12721 Y SERIES - 450 HEAVY DUTY SAND FILTER						
752046-7	LOT DE MAINTENANCE X X SERIES SERVICE MAINTENANCE SET	752					
752047	LOT DE MAINTENANCE YC/YK (sauf YC5/YK5) YC/YK SERVICE MAINTENANCE SET (except YC5/YK5)	889					
752048	LOT DE MAINTENANCE YC5/YK5 YC5/YK5 SERVICE MAINTENANCE SET	1.026					

1 Installations kit  
2 Salinity (salt) kontrol  
3 Auto. Flushing  
4 Remote panel  
5 Dual spending

## Kabola oliefyr

Kabola har gennem mere end 50 år leveret pålidelige diesel varmesystemer, der kræver et minimum af vedligeholdelse til skibe, både, lastbiler og busser.

Produktsortimentet dækker hele spektret fra små pottefyre til automatiske oliefyre med såvel varme som varmt brugsvand.

For yderligere information kontakt Johs Thornam A/S 44 34 20 40

## Oliefyr

Kabola oliefyr består af kedel, brænder, cirkulationspumpe, oliefilter og rumtermostat.

### HR serien, 8 - 20 KW

Varenr.	Beskrivelse	kr
30-001	HR300 / 230 VOLT 8-10kW	29.127,50
30-002	HR300 / 230 VOLT 8-10kW CALORIFIER	33.578,75
26-001	HR400 / 230 VOLT 12-14kW	31.381,25
26-002	HR400 / 230 VOLT 12-14kW 5L/MED COMBI	44.241,25
26-003	HR400 / 230 VOLT 12-14kW CALORIFIER	36.986,25
37-001	HR500 / 230 VOLT 15-20kW	33.578,75
37-002	HR500 / 230 VOLT 15-20kW 7L/MED COMBI	47.043,75
37-003	HR500 / 230 VOLT 15-20kW CALORIFIER	38.086,25



### KB serien, 7 - 40 KW og er super kompakt

Varenr.	Beskrivelse	kr
44-001	KABOLA KB20 230V 7kW KOMPLET	49.297,50
44-002	KABOLA KB20 230V 7kW CALORIFIER KOMPLET	52.650,00
46-001	KABOLA KB40 230V 13kW KOMPLET	51.425,00
46-002	KABOLA KB40 230V 13kW COMBI	56.002,50
46-003	KABOLA KB40 230V 13kW BOILER	54.927,50
47-001	KABOLA KB45 230V 18kW KOMPLET	53.802,50
47-002	KABOLA KB45 230V 18kW COMBI KOMPLET	58.225,00
47-003	KABOLA KB45 230V 18kW CALORIFIER KOMPLET	56.060,25
49-001	KABOLA KB75 230V 40kW KOMPLET	56.002,50
49-002	KABOLA KB75 230V 40kW COMBI KOMPLET	62.762,50
49-003	KABOLA KB75 230V 40kW CALORIFIER KOMPLET	61.062,50

## Standard skorstenssæt

Skorstenssættene indeholder 2 m fleksibelt rør, lyddæmper og skroggennemføring.

Varenr.	Beskrivelse	kr
14-N105	SKORSTENSSÆT Ø60 mm FOR HR300	5.263,00
14-N106	SKORSTENSSÆT Ø80 mm FOR HR400 & HR500 & KB-SERIEN	5.511,00
14-N107	SKORSTENSSÆT Ø100 mm FOR HR400 & HR500 & KB-SERIEN	5.759,00
14-N077	RUSTFRIT FLEXIBELT RØR Ø 60 mm 1,0 m	470,00
14-N078	RUSTFRIT FLEXIBELT RØR Ø 80 mm 1,0 m	470,00
14-N079	RUSTFRIT FLEXIBELT RØR Ø 100 mm 1,0 m	486,00
14-N176	ISOLERING FOR RUSTFRIT FLEXIBELT RØR Ø60 mm 1,0 m	703,00
14-N177	ISOLERING FOR RUSTFRIT FLEXIBELT RØR Ø80 mm 1,0 m	798,00
14-N178	ISOLERING FOR RUSTFRIT FLEXIBELT RØR Ø1000 mm 1,0 m	870,00





# SELMAR WATERMAKER

Progress er en serie meget kompakt watermaker og bygget i rustfrit stål. Stor ydelse, lavt strømforbrug v/ 12 – eller 24 Volt, Progress Lux skal have 230 Volt. Velegnet til både uden dieselgenerator ombord. Nem at installere, bruge og vedligeholde.

Selmar kan levere modeller fra 15 l/time til 5700 l/time.

Desuden fås optioner som UV lys - forsterilisering, sandfilter - bedre filtrering ved mudret saltvand, Aktiv Carbon filter, Remote control, Automatisk skyllesystem m.m.

Varenr.	Beskrivelse	Vejl. uds. incl. moms
SEL-MC40	PROGRESS MC40, 15 L/TIME 360 L/DAG FORBRUG: 12 VOLT - 18 AMP ( 24 VOLT 9 AMP ) 64 X 25 X 22 cm, VÆGT 20 kg	kr 45.450,00
SEL-MC80	PROGRESS MC80/P, 30 L/TIME 720 L/DAG FORBRUG: 12 VOLT 18 AMP ( 24 VOLT 9 AMP ) 64 X 25 X 22 cm, VÆGT 24 kg	kr 53.309,00
SEL-MC120	PROGRESS MC120, 50 L/TIME 1200 L/DAG FORBRUG: 12 VOLT 32 AMP ( 24 VOLT 18 AMP ) 64 X 25 X 22 cm, VÆGT 28 kg	kr 67.417,00
SEL-MC LIGHT	PROGRESS LIGHT 25 L/TIME 600 L/DAG FORBRUG: 12 VOLT 28 AMP ( 24 VOLT 14 AMP ) 52 X 25 X 29 cm, VÆGT 29 kg	kr 48.878,00
SEL-MC/25 LUX	PROGRESS LUX 25 L/TIME 600 L/DAG FORBRUG: 220 VOLT 50 HZ, 0,5 KW 69 X 35 X 30 cm, VÆGT 24 kg	kr 65.014,00
SEL-MC/50 LUX	PROGRESS LUX 50 L/TIME 1200 L/DAG FORBRUG: 220 VOLT 50 HZ, 0,5 KW 69 X 35 X 30 cm, VÆGT 28 kg	kr 73.100,00
SEL-BA200	BASIC BA 200, 30 L/MIN 720 L/DAG FORBRUG: 220 VOLT 50 HZ, 0,75 KW 70 X 30 X 23 cm, VÆGT 32 kg	kr 47.239,00
SEL-BA400	BASIC BA 400, 60 L/TIME 1440 L/DAG FORBRUG: 220 VOLT 50 HZ, 0,75 KW 70 X 30 X 23 cm, VÆGT 37 kg	kr 60.530,00
SEL-ECF30	VICTORY ECF 30, 40 L/TIME 960 L/DAG FORBRUG:12 VOLT 5 AMP ( 24 VOLT 2,5 AMP ) 70 X 35 X 23 cm, VÆGT 30 kg	kr 54.045,00
SEL-ECF60	VICTORY ECF 60, 70 L/TIME 1680 L/DAG FORBRUG:12 VOLT 5 AMP ( 24 VOLT 2,5 AMP ) 70 X 35 X 23 cm, VÆGT 35 kg	kr 72.540,00
SEL-ECF90	VICTORY ECF 90, 110 L/TIME 2640 L/DAG FORBRUG:12 VOLT 5 AMP ( 24 VOLT 2,5 AMP ) 70 X 35 X 23 cm, VÆGT 40 kg	kr 88.353,00



## Generatorer

Fischer Panda diesel marine generatorer er det ideelle valg for til såvel motor- som sejlbåde. En Fischer Panda marine generator er kompakt, let, stille og meget effektiv. Generatoren er monteret i et støjskjold, der sikrer, at støjniveauet er meget lavt og vibrationerne minimale.

For yderligere information og størrelser kontakt Johs. Thornam.

Part number	Generator-Model	Nominal power kW/kVA	Diesel engine	Sound insulation	Vejl. uds. incl. moms
<b>ECO POWER / S-SERIES</b>					
01.01.01.006P	PANDA 4000S NEO 4,0 / 4,7		FPE320	GFK 3D	kr 55.221,00
<b>PERFECT POWER / I-SERIES / VARIABLE SPEED 1)</b>					
0 000 227	PANDA 5000i.NEO	0-4,0 / 5,0	FPE320	GFK 3D	kr 61.264,00
0 000 176	PANDA 5000i	0-4,0 / 5,0	KU EA300	GFK 3D	kr 91.303,00
0 000 183	PANDA 8000i	0-6,4 / 8,0	KU Z482	GFK 3D	kr 112.839,00
0 000 181	PANDA 10000i	0-8,0 / 10,0	KU Z602	GFK 3D	kr 124.821,00
0 000 182	PANDA 15000i-230	0-12,0 / 15,0	KU D902	GFK 3D	kr 154.182,00
0 000 188	PANDA 15000i-400 V	0-12,0 / 15,0	KU D902	GFK 3D	kr 168.727,00
0 000 364	PANDA 25i - 230 V	0-20,0 / 25,0	KU V1505	GFK 3D	kr 187.127,00
0 015 112	PANDA 25i - 400 V	0-20,0 / 25,0	KU V1505	GFK 3D	kr 212.268,00
<b>KOMPACT POWER / ASYNCHRONOUS 3000 RPM 2)</b>					
0 000 168	PANDA 8000X	6,8 / 8,0	KU Z482	GFK 3D	kr 105.670,00
0 000 281	PANDA 10000X	8,0/9,4	KU Z602	GFK 3D	kr 117.225,00
0 000 169	PANDA 12000X	10,2/12,0	KU D722	GFK 3D	kr 119.580,00
0 000 170	PANDA 15000X	12,7/15,0	KU D902	GFK 3D	kr 133.010,00
0 014 870	PANDA 18X	15,3/18,0	KU D1105	GFK 3D	kr 152.515,00
0 014 869	PANDA 24X	20,4/24,0	KU V505	GFK 3D	kr 175.197,00
<b>KOMPACT POWER / ASYNCHRONOUS 1500 RPM 1)2)</b>					
0 014 958	PANDA 7,5-4	6,5/7,6	KU D1105	GFK 3D	kr 155.474,00
0 014 959	PANDA 9-4	8,0/9,4	KU D1105	GFK 3D	kr 158.829,00
0 014 908	PANDA 12-4	10,5/12,3	KU V1505	GFK 3D	kr 176.916,00
0 014 968	PANDA 22-4	18,6/21,9	KU V2403	MPL 4DS	kr 239.118,00
0 014 987	PANDA 30-4	25,5/30,0	MI S4S	MPL 4DS	kr 262.217,00
	PANDA 40-4	35,0/41,1	MI S4 DT	MPL 4DS	kr 315.198,00
<b>HYBRID POWER / DC-GENERATORS / VARIABLE SPEED 3)</b>					
0 004 934	AGT-DC 4000-12V		3,2 KU EA300	GFK 3D	kr 84.530,00
0 000 352	AGT-DC 4000-24V		3,2 KU EA300	GFK 3D	kr 85.562,00
0 000 355	AGT-DC 5000-12V		4 KU Z482	GFK 3D	kr 110.380,00
0 014 776	AGT-DC 6000-24V		4,8 KU Z482	GFK 3D	kr 112.766,00
0 015 025	AGT-DC 8000-24V		6,4 KU D722	GFK 3D	kr 130.760,00
0 015 031	GT-DC 10000-48V		9,1 KU D722	GFK 3D	kr 134.646,00
0 015 064	AGT-DC 11000-48V		10,9 KU D902	GFK 3D	kr 140.304,00



- Op til Panda 12-4 cos Phi 0,85 for korte take-off strøm til induktive belastninger, ellers cos Phi1
- Fra Panda 17-4 cos Phi 0,85 valgfri start ydeevne med kompensation eller startstrøm boost, ellers co sPhi1
- 3) AGT-DC 4000-8000: Tillæg for mærkespænding> 48V: + 3% (ekstern diode blok / skab)  
Ab / fra AGT-DC 10000: Inklusive ekstern diode blok / skab / inklusiv ekstern redtifier / kabinet
- 4) Alle varenumre til Panda 30iCx; 230 V enfaset

Tekniske data henvises til Fischer Pandas hjemmeside, eller kontakt venligst Johs Thornam A/S 44342040

Fischer Panda leverer også i US spændinger 120/240 V 60Hz.  
Kan Leveres i henhold til US Emmission Certificate TIER4



# Pains Wessex Nødsignaler

## De professionelle valg

PW signaler har markedets højeste kvalitet og pålidelighed.

Alle produkter testes, før de bliver frigivet på markedet, for lysstyrke, farve, brændetid og pålidelighed.

Holdbarheden er 3 år i korrekt beholder.

Varenr.	Beskrivelse	Vejl. uds. incl. moms	
55532-Q	PAINS WESSEX SEJLER KIT 4 RØDE HÅNDBLUS, 2 RØDE NØDRAKETTER & 3 LITER BEHOLDER	kr	775,00
55533-Q	PAINS WESSEX LANGTUR SEJLER KIT 4 RØDE HÅNDBLUS, 4 HVIDE HÅNDBLUS, 2 RØDE NØDRAKETTER & 3 LITER BEHOLDER	kr	1.200,00
55540-Q	PAINS WESSEX 7 SØMIL KIT 2 RØDE HÅNDBLUS, 2 RØDE NØDRAKETTER, 2 RØGIGNALER & 3 LITER BEHOLDER	kr	1.150,00
50672	PAINS WESSEX RØD FALDSKÆRMSRAKET	kr	223,00
52900	PAINS WESSEX RØD HÅNDBLUS	kr	82,00



52900

Det rigtige valg - det rette produkt.

Hepworth og Wynn Marine sikrer udsynet. Bruges af pilot-både, Fairline, US Coast Guard med flere.











Forhandler :